



# User Manual for Diesel & Steam Decoders

Third edition, May 2012

LokSound Select  
LokSound Select micro  
LokSound Select Direct



<b>1. Important Notes – Please read this chapter first... 5</b>	
<b>2. Introduction to LokSound Select ..... 5</b>	
2.1. Decoder Ratings.....6	
<b>3. Operation ..... 7</b>	
3.1. Function Assignments.....7	
3.2. Using your LokSound Select Decoder under DCC.....8	
3.3. Using your LokSound Select Decoder under DC .....9	
<b>4. Decoder Installation..... 10</b>	
4.1. Installation requirements ..... 10	
4.2. Installing in locomotives without interface ..... 10	
4.2.1. Wiring diagram..... 10	
4.2.2. Motor and track connections ..... 10	
4.2.3. Speaker installation..... 13	
4.2.3.1. Multiple Speaker installations..... 13	
4.2.4. Function outputs connections ..... 13	
4.2.4.1. Overload protection ..... 14	
4.2.4.2. Suitable light bulbs ..... 14	
4.2.4.3. Using LEDs..... 14	
4.2.4.3.1. LokSound Select / LokSound Select micro ..... 14	
4.2.4.3.2 LokSound Select Direct ..... 14	
4.2.5. Install the CAM..... 15	
4.2.5.1. Hall sensor IC (H0 only)..... 15	
4.2.5.2. Reed switch sensor (H0 only) ..... 15	
4.3. Installing LokSound Select in a DCC-ready model..... 16	
4.4. Installing LokSound Select Direct..... 16	
4.5. Connecting capacitors ..... 16	
4.5.1. All LokSound H0 and micro decoders..... 16	
4.5.2. Optional “PowerPack” ..... 16	
<b>5. Decoder settings (programming) ..... 17</b>	
5.1. Basics of DCC programming ..... 17	
5.1.1. Configuration variables (CV) ..... 17	
5.1.2. Standardization in the NMRA..... 18	
5.1.3. Bits and Bytes ..... 18	
5.1.4. Programming methods ..... 18	
5.1.4.1. Programming on the Main ..... 18	
5.1.4.2. Service Mode Programming ..... 18	
5.1.5. Programming procedure using various DCC systems 19	
5.1.6. Programming with the ESU LokProgrammer ..... 19	
5.1.7. Resetting the CVs or starting over ..... 19	
5.2. Setting up your LokSound Select..... 19	
5.2.1. Step 1: Address Settings ..... 19	
5.2.1.1. Primary Address ..... 19	
5.2.1.2. Extended Address ..... 19	
5.2.2. Step 2: Configuring the decoders behavior ..... 20	
5.2.2.1. Acceleration / Deceleration ..... 20	
5.2.2.2. Starting voltage, Max and Medium Speed ..... 20	
5.2.2.3. Speed curve ..... 21	

5.2.2.4. Adjust forward and reverse trim.....	21	5.2.7. Step 7: Modifying the Sound Effects .....	32
5.2.2.5. Switching mode.....	21	5.2.7.1. Air horn / whistle selection.....	32
5.2.2.6. Analog DC mode.....	21	5.2.7.2. Prime mover sound selection .....	33
5.2.3. Step 3: Configuring for Consist Operation .....	21	5.2.7.3. Bell selection.....	33
5.2.3.1. Consist Function Control.....	22	5.2.7.4. Brake squeal selection.....	33
5.2.4. Step 4: Setting up the Motor Control.....	22	5.2.7.5. Bell rate .....	34
5.2.4.1. Adjusting Back-EMF.....	22	5.2.7.6. Adjust the sound volume .....	34
5.2.4.2. Parameters for frequently used motors .....	22	5.2.7.7. Prime mover startup delay .....	35
5.2.4.3. Automatic Adjustment.....	23	5.2.7.8. Manual notching (Diesel only).....	35
5.2.4.4. Manual adjustment.....	23	5.2.7.9. Synchronizing the steam chuff (Steam decoder only)36	
5.2.4.4.1. Parameter "K".....	23	5.2.7.10. Random sounds.....	37
5.2.4.4.2. Parameter "I" .....	23	5.2.7.11. Pop valve sound (Diesel only) .....	37
5.2.4.4.3. Reference Voltage.....	28	5.2.8. Step 8: Additional Functions of the LokSound Select37	
5.2.4.4.4. Slow speed amplifier.....	28	5.2.8.1. Brake sectors .....	37
5.2.4.5. Turning off Load compensation.....	28	5.2.8.1.1. Brake on DC .....	37
5.2.4.6. Dynamic Drive control: Up and down the hill .....	28	5.2.8.1.2. Brake on Asymmetrical DCC signal (ABC braking)37	
5.2.5. Step 5: Function mapping.....	28	5.2.8.2. Constant brake distance .....	38
5.2.5.1. Index CV access .....	28	5.2.8.3. Analog DC settings.....	38
5.2.5.2. Function Mapping table.....	29	5.2.8.3.1. Analog DC startup and max voltage .....	38
5.2.6. Step 6: Configuring the function outputs.....	29	5.2.8.3.2. Analog function Enable .....	38
5.2.6.1. Available lighting effects.....	29	5.2.9. Prime mover Sound On / Off behavior.....	39
5.2.6.2. Modifying the lighting effect.....	30		
5.2.6.3. Grade Crossing holding time.....	32	<b>6. Firmware Update .....</b>	<b>39</b>
5.2.6.4. Flash Rate .....	32	<b>7. List of CVs .....</b>	<b>40</b>

<b>8. Support</b> .....	<b>44</b>
<b>9. Appendix</b> .....	<b>44</b>
9.1. How to program long addresses .....	44
<b>10. Warranty</b> .....	<b>46</b>

Copyright 1998 - 2012 by ESU LLC. Electrical characteristics and dimensions are subject to change without prior notice. All rights reserved. ESU might not be held responsible for any damage or consequential loss or damage caused by inappropriate use of the product, abnormal operating conditions, unauthorized modifications to the products etc. Not suitable for children under 14 years of age. Inappropriate use may result in injury due to sharp points and edges.

Märklin® is a registered trademark of the company Gebr.Märklin® and Cie. GmbH, Göppingen, Germany. RailCom® is a registered trademark of the company Lenz Elektronik GmbH, Giessen, Germany. All the other trade marks are owned by their respective right holders.

ESU continues to develop the products according to the company's politics. Therefore, ESU reserves the right to carry out changes and improvements on the products listed in this manual at any time and without any advanced note. Duplications and reproductions of this documentation are strictly forbidden and need to be allowed by ESU in writing.

# Introduction to LokSound Select

## 1. Important Notes – Please read this chapter first

Congratulations on your purchase of an ESU LokSound Select decoder. This manual will guide you step by step through the features of your decoder. It will be a great temptation to begin connecting wires immediately, but before you install your LokSound Select there are some simple precautions you should take.

- The LokSound Select is exclusively intended for use with model train layouts.
- Never make connections to the decoder while it is powered. Doing so makes for an accident waiting to happen.
- Do not remove the heat shrink sleeve on the decoder.
- Make sure that neither the LokSound Select decoder nor any bare wire ends come into contact with the engine chassis (risk of short circuit). Cover any bare ends of unused wires.
- Never allow the decoder leads to come in contact with any DCC track wiring except those specifically designed for that purpose.
- Never wrap the decoder in insulation tape, since this may cause overheating
- Make sure that no wires are squeezed or cut by the model's transmission parts when reassembling the engine
- Do not expose to wet and humid conditions

## 2. Introduction to LokSound Select

The LokSound Select is a versatile DCC & DC “Dual Mode” decoder integrating a full-featured, 8 channel sound system, six lighting outputs and a 1.1A motor controller. Due to its unique thermal design, it does not need any heat sinks.

### DECODER FEATURES

- Compatible with all NMRM DCC standards & RPs
- Supports short and long addressing
- Supports Advanced Consisting
- 14, 28 and 128 Speed Steps (auto detect)
- Standard and User loadable Speed tables
- Supports Service Mode Programming (without the need for any service track booster or other circuitry) and Operations Mode Programming
- LokSound Select can be used on “legacy” layout and can also be controlled with a DC power pack, too. It can change between DC and DCC operation at any time “on the fly”.
- With the use of our LokSound Programmer, programming can be even more comfortable by using your computer to adjust the many CVs and settings.

### SOUND FEATURES

The LokSound Select comes with a 32 MBit memory chip. The sounds stored therein are our own recordings which were made by using the latest recording equipment and have been digitally re-mastered for the best audio possible. The sounds are transferred to a class “D” audio amplifier via eight polyphonic sound channels. LokSound Select decoders offer the following unique features:

- Multiple whistle and horns: Each LokSound Select offers many whistle & horns. By just changing one CV, you can select your favorite one. This allows an easier adjustment to your model.
- Playable whistle: The LokSound Select supports a very fast responding whistle function. By just pressing your throttle's button, you can blow the whistle like the real engineer.
- 8 channel sound: The LokSound Select can playback up to 8 sounds at the same time. This will result in the most realistic expe-

# Operation

rience available today.

- Manual notching: The diesel speed steps can be either manually controlled by function keys or automatically based on the speed.
- Valuable exhaust synchronization: The exhaust chuff are automatically generated when the locomotive is moving and can be synchronized by an external cam or precisely computed by the LokSound Select.
- Individual volume control: The volume of all sound effects can be adjusted individually.

Steam decoders can produce over 20 sound effects, including the bell, air pump, exhaust chuff, coupler, steam release, cylinder cocks, brake release, side rod clank, blower, injector, Fireman Fred and many more. Synchronizing the steam chuff rate by using two CVs only virtually eliminates the need for a cam, but can of course be connected.

Diesel decoders can produce over 20 sound effects, including the engine start-up and shutdown, prime mover sounds through all eight notches, bell, air horn, air compressor, dynamic brakes, fans, brake squeals, coupling and uncoupling, detector sounds, rail clank and many more.

## CUSTOMIZE YOUR SOUNDS

Unlike other manufacturers, LokSound Select offers you two options to customize your engine. The most simple is by using one (!) CV. You can select the prime mover sound, the desired whistle or horn and the bell. Each LokSound Select offers various options on that.

However, if you are still unsatisfied with the result, you may at any time use the famous LokSound Programmer to download new sounds into the LokSound Select. We offer numerous "ready-made" sound packages for easy downloading.

## SUPERIOR MOTOR CONTROL

ESU offers load compensation (using B-EMF) since 1999. While other manufacturers seem only to focus on the sound options, the LokSound Select offers the 5th generation of motor control resulting in smooth and precise locomotive operation. We at ESU believe that good motor control is mandatory for model trains:

Even the best sound is worthless if the locomotive is not running smoothly!

Regardless if you are using coreless or conventional DC motors, the LokSound Select's unique auto-detection function can measure the characteristics and adjust the internal settings. There is no need to fiddle around with many CVs to adjust to the engine. Due to Dynamic Drive Control (DDC) you can limit the influence of the load control and operate really smoothly around the depot and over turnouts, while on the main, when going uphill the engine prototypically slows down.

## LIGHTING EFFECTS

Each LokSound Select include 6 (!) outputs with 0.25A current each that can be allocated individually to a light effect, which simulates the light patterns of many popular warning beacons. Besides D312 Rotary beacon, strobe and alternate flashing, there is a firebox flicker, smart flicker, Mars light, Gyalight, Ditch lights (two types), Oscillating Headlights, Stratolight and many more.

The Rule 17 dimmable headlight can be either controlled automatically or by function button. A LED brightness correction feature now also allows using LEDs for lighting effects. This is an important feature since LEDs behave differently than bulbs.

## 2.1. Decoder Ratings

Features	Select H0	Select Micro	Select Direct
Track Voltage	27 V maximum	27 V maximum	27 V maximum
Operation modes	DCC & DC (Dualmode)	DCC & DC (Dualmode)	DCC & DC (Dualmode)
Steady state motor current	1.1A	0.75A	0.75A
Function output current	0.25A each	0.25A each	0.25A each
Number of function outputs	6	4	6
Audio amplifier	2W@40ohms load	2W@40ohms load	2W@40ohms load
Speaker impedance	4-8 Ohms	4-8 Ohms	4-8 Ohms
Memory capacity	32 MBit	32 MBit	32 MBit
Number of Sound channels	8	8	8
Dimensions	(Gen.1) 1.4x0.51x0.25"; (Gen.2) 1.14x0.59x0.25"	0.98x0.42x0.15"	1.02x0.62x0.18"

# Operation

## 3. Operation

Every LokSound Select decoder comes pre-programmed ready to use. You can use it either on DCC or on DC voltage.

### 3.1. Function Assignments

#### Diesel Decoders

Function Key	Effect
F0	Directional Headlights
F1	Bell
F2	Playable Airhorn
F3	Coupler Clank
F4	Dynamic Brake
F5	AUX3 output (pre-set to Mars light)
F6	AUX1 + AUX2
F7	Switching Mode
F8	Prime Mover Sound On / Off ( Mute )
F9	Manual Notching (up)
F10	Manual Notching (down)
F11	Radiator ( Fan ) Sound
F12	Dimmer (Headlights)
F13	AUX4 function output
F14	Detector Sound
F15	Crossing Communication
F16	Rail Clank ( works only if F8 is On )
F17	Brake Set / Release
F18	Sanding Valve
F19	Shor Air let off
F20	Compressor
F21	Pop valve

#### Steam Decoders

Function Key	Effect
F0	Directional Headlights
F1	Bell
F2	Playable Whistle
F3	Coupler clank
F4	Blower (Blow down the boiler)
F5	AUX3 output (pre set to flickering firebox)
F6	AUX1 + AUX2 output (pre set to Ditch light)
F7	shunting mode
F8	Sound Mute (On/Off)
F9	Dimmer (Headlights)
F10	Oil burner (for oil fired locomotives)
F11	Coal shoveling (for coal burning locomotives)
F12	Air pump
F13	AUX4 function output
F14	Injector
F15	Crossing Communication
F16	Railclank
F17	Brake set/ Brake release
F18	Open cylinder cocks
F19	-
F20	Short Whistle
F21	-



This is the default function mapping only. You can change the function keys at any time. See chapter 5.2.5 for details.

It may be the case that some LokSound Select decoders use a different function assignment. You can find the correct function assignment for any of our LokSound Select decoders on our website.

# Operation

Go to the sound download page for LokSound Select decoders. In the list of all available decoders, expand the list by clicking on the “+” mark to see the details.

## 3.2. Using your LokSound Select Decoder under DCC

The default address assigned to the LokSound Select is 3. Simply set your controller to this locomotive number and place it on the mainline. If the installation is done properly, it should react as described below.

### HEADLIGHTS

Press the F0 (or light button) to turn on the headlights. Reverse locomotive direction and the headlight should turn off while the backup light turns on. If even this simple operation does not work, please make sure that on the controller, locomotive number 3 is set to use 28 or 128 speed steps.

While waiting in a station, you may use the F9 key to dim the headlight for an oncoming train.

### BELL

To ring the bell, simply press the F1 button on your throttle. Because this is an On/Off function, the bell will continue to ring until you turn it off by pressing F1 again.

### HORN / WHISTLE

To activate the air horn (or whistle on steam decoders), press F2 on your cab: The longer you press the key, the longer the horn will blow. While this allows you to make short or long signals, F20 is designated as a short horn to enable to you create short “toots” regardless of how responsive your cab controls are.



On some throttles, the F2 key is also designed to work as an On/Off key. For these throttles, you must press F2 again to turn the horn off.

### PRIME MOVER SOUND (DIESEL DECODERS)

To start the diesel engine, press the F8 key. The diesel engine will crank over several times and settle into the idle sound. Once the engine has reached idle, it will change RPM automatically in response to changes in the locomotive speed. The LokSound Select will follow all “diesel notches” up to full speed in correspondence to the real speed. Further, based on the load conditions, you may hear that the motor needs to generate a lot of “power”. Try to quickly move the throttle from low to full speed and see what happens. Also, try to slowly change the speeds to increase the engine speed step by step.

To turn of the diesel engine, press the F8 button at any time. If the locomotive is stopped and the sound is idling, you can hear the engine shut down sequence sound. If the locomotive is moving while you press F8, the sound is muted immediately.

Because of their size, a real diesel locomotive engine does not rev as quickly as the motor on your car. A prototypical diesel requires at least 20 to 30 seconds to reach full speed and about the same amount of time to return to idle. Because your LokSound Select decoder uses real recordings from real engines, it will also require a certain amount of time to reach the desired diesel speed step. Based on the momentum settings, it may happen that the speed of your model train does not always perfectly match the diesel sound you can hear.

In order to avoid this, please try to set the momentum settings to a quite high level (see chapter 5.2.2.2 for details) and try to make gradual changes to your throttle speed.

If you try to operate your model train as prototypical as possible, you will enjoy the best results from the diesel sound of your LokSound Select!



# Operation

## PRIME MOVER SOUND (STEAM DECODERS)

To start the steam sound, press the F8 key. You will immediately hear the boiler sounds and various random sound effects like air pump, shoveling coal, steam blow down can be heard while the locomotive is stopped. Just as you start to move the engine, you'll hear the brake release sound, and the exhaust chuffs will be played automatically. The sound and volume of the exhaust chuffs will be adjusted based on the throttle setting, the momentum settings and the actual load of the locomotive. There is no need to adjust any CV for doing so, it is all done automatically by the LokSound Select!

To turn off the steam sound, press the F8 button at any time.

Each LokSound Select contains up to 4 different prime mover sounds. This unique feature allows you even better adjustment of the decoder to your model. See chapter 5.2.7. to learn how easy you can change this sound.

## DYNAMIC BRAKES

Diesel locomotives often use dynamic braking when slowing the vehicle. This means they use the electric traction motors as generators. The generated electrical power is then dissipated as heat in brake grid resistors. In order to avoid overheating these resistors, a cooling fan is often enabled. Dynamic braking however lowers the wear of friction-based braking components.

To turn the Dynamic Brakes on / off, press the F4 button of your throttle. You will hear the cooling fan of the dynamic brakes, and also the momentum settings of the decoder will be changed so that the engine will brake faster if you reduce the throttle speed.

## INJECTOR (STEAM)

The injector feeds water to the boiler. Pressing F14 will turn on and off the sound of the injector.

## OTHER FUNCTIONS AND SOUND EFFECTS

Depending on the number of function keys available on your DCC system, you might enable additional sound effects such as Air Compressor, Radiator sounds, Radio communication and oth-

ers by simply pressing the appropriate function key. Because the LokSound Select offers up to 8 sound channels, most sounds can be played at the same time.

### **3.3. Using your LokSound Select Decoder under DC**

Although we highly recommend the usage of a DCC system in order to enjoy all the features of the LokSound Select, you may also use your conventional DC controller for the control. You will be able to control the motor of the locomotive and will also hear the engine sounds. However, you will have no chance to enable additional sound effects such as bell or horn because of the lack of any function buttons on these DC controllers.

Please note that the engine will only start moving when the track voltage reaches around 8 – 9 Volts. So you need to turn up your DC throttle to a much higher voltage than usual.

# Decoder Installation

## 4. Decoder Installation

### 4.1. Installation requirements

The engine must be in good mechanical condition: only an engine running smoothly in analog mode should be modified for digital operation. An engine running poorly in analog mode will not operate satisfactorily in digital mode – even with the best digital decoder. Check and clean or replace any worn parts such as motor brushes, wheel contacts, lamps etc.

Always remove the engine from the track when doing maintenance work or modifications. Make sure that no voltage is applied – intentionally or accidentally – while you work on the model.

The LokSound Select decoder has a certain size: make sure, that the decoder fits easily into the engine, that no pressure is applied when replacing the housing onto the chassis and that no wires are squeezed between other parts. Further, make certain that wired do not obstruct moving parts such as transmissions and trucks.

Never pack a LokSound decoder in foam pads etc. The decoder heats up during operation; good heat dissipation is essential. Provide ventilation for the decoder if possible, mounting the decoder so that some airflow can occur. Also, keep the decoder away from other heat sources such as the motor or bulbs.

Electronic components are sensitive to electrostatic charges: always make sure that your work place is grounded. If necessary, use an earthed wristband.

#### SPEAKER CONSIDERATIONS

LokSound Select decoders may be used with any speaker or combination of speakers whose total impedance is at least 4 ohms or higher. You should use the largest speaker possible to get the best volume and bass sound. We recommend the usage of the ESU speakers which are optimized for use with the LokSound Select. All of them are high power, 2W speakers with an impedance of 4 ohms.

The correct position of the speaker is crucial to achieve high quality sound. Also, a speaker that is installed without an enclosure will not generate good sound. The reason is simple: To generate any appreciable sound, the speaker must develop air pressure. Without the enclosure, an opposite pressure behind the speaker cancels the air pressure developed by the front of the speaker. The front and the back surface of the speaker must be isolated from each other in order to get any acceptable sound. Therefore carefully select the location and sound chamber for the speaker. The speaker must be installed in such a way that the sound waves are not unduly blocked.



Please handle speakers with extreme care: don't apply pressure or touch the membrane! The speaker's magnets are very powerful! Keep all metal items away and secure the speaker firmly when soldering. The soldering iron may pull the magnetic field of the speaker and destroy it.

### 4.2. Installing in locomotives without interface

Begin by mounting the speaker and securing the decoder in place using double-sided tape. Not every engine has a digital interface and thus the wiring becomes more elaborate: Disconnect any existing wires within the engine and any connection to the chassis.

#### 4.2.1. Wiring diagram

Please follow the wiring diagram shown in figure 1-4 on the next pages, depending on what version of LokSound Select you use.

#### 4.2.2. Motor and track connections

Both motor leads must be positively potential-free, in other words they may not have any contact to the chassis or body or the wheels and wheel contacts. Take special care to remove any connections to the chassis. Note that some motor brush connections are made using a spring contact to the chassis. If so, you need to remove this spring as well.

Make notes of which motor lead connects the motor with the right and the left wheel contact. This avoids mistakes and assures that your locomotive runs in the right direction.

# Decoder Installation

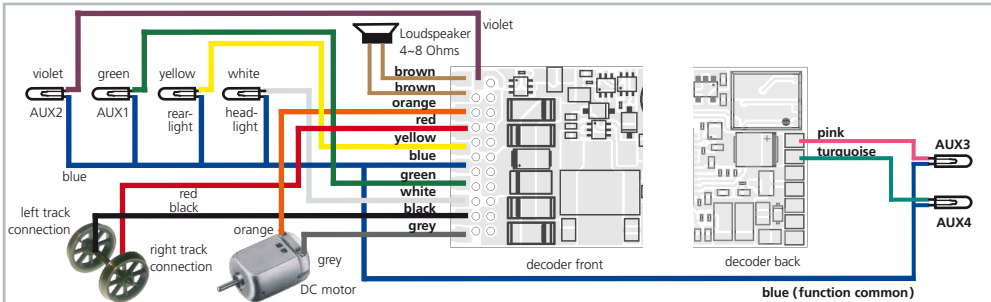

Figure 1: General wiring diagram of LokSound Select (2nd Generation)

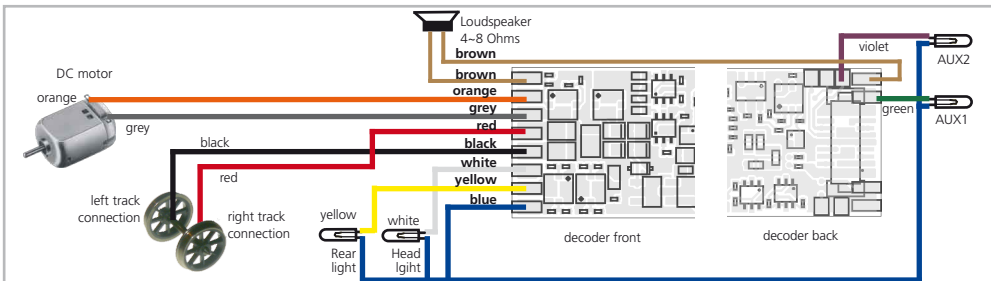

Figure 2: General wiring diagram of LokSound Select micro

# Decoder Installation

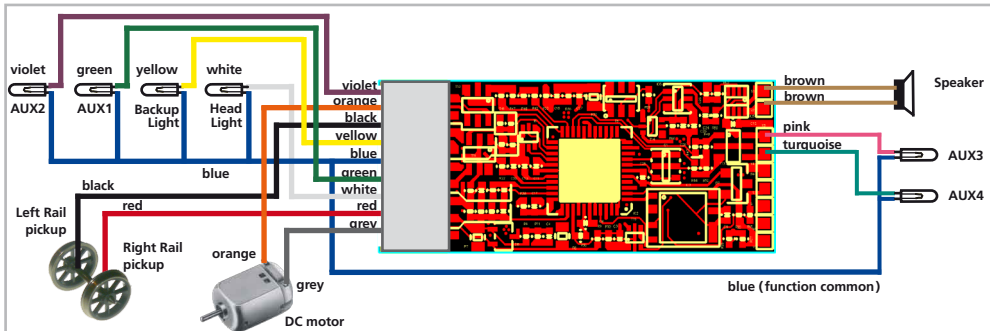

Figure 3: General wiring diagram of LokSound Select (1st Generation)

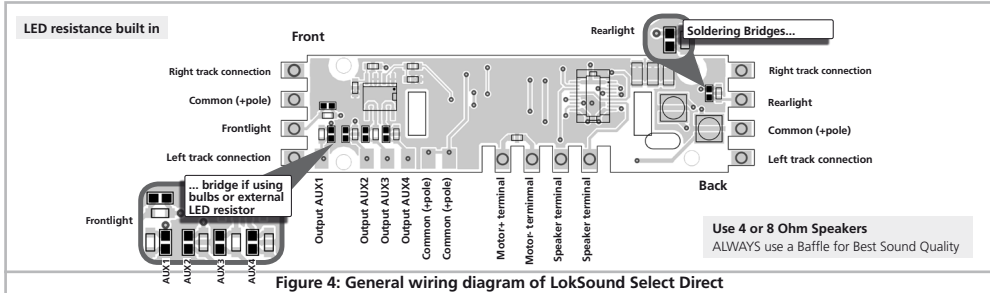

Figure 4: General wiring diagram of LokSound Select Direct

# Decoder Installation



Please check all connections with an Ohmmeter. Search for short circuits, particularly between the motor leads and the wheel contacts. Do not proceed further if you are not sure about the isolation status.

- Connect the red wire to the right rail pick-up, the black wire to the left rail pick-up
- Connect the orange wire with the motor terminal, which was originally wired to the right wheel pick-up (center pick-up in AC models).
- The gray wire goes to the terminal, which was originally connected to the left wheel pick-up
- Exchanging the wires changes direction of travel.

## 4.2.3. Speaker installation

Connect the speaker to the 2 dark brown wires of the LokSound Select decoder. Make sure that you use a small soldering iron (max. 20W) and only heat the marked spots as shown in the figure (close to the edge of the small contact plate). LokSound Select does not need any capacitor wired in series with the speaker as required by some other brands.



The total impedance of all speakers should be in a range of 4–16 Ohms. Lower impedance may result in damage of the decoder.

The polarity of the speaker is not important for single speaker installation. An optimal sound effect is achieved by putting the speaker into a sound chamber, which is supplied with any ESU speaker. Feed the speaker wires through a small hole in the sound chamber.

## 4.2.3.1. Multiple Speaker installations

When wiring multiple speakers, the speaker polarity is important. If a speaker is wired “backwards” with respect to another speaker, each speaker’s sound wave will be out of phase with the other one. As a result, it will cancel each other out resulting in very poor, extremely low sound volume! Some speakers do not provide any polarity mark; in such cases you need to test the wiring before the final speaker installation!

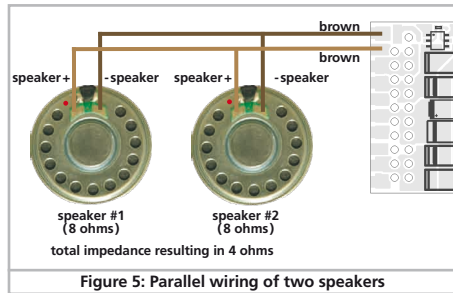

Figure 5: Parallel wiring of two speakers

## 4.2.4. Function outputs connections

You can wire any kind of load such as light bulbs, LEDs, smoke generators or similar devices to the function outputs provided the maximum current draw is less than that of the decoder output.



The permitted maximum current draw per function output is listed in chapter 2.1



Please make sure that the load does not exceed the permitted maximum current and there are no short circuits. The outputs of the LokSound Select have protection but if an external voltage is applied, the outputs may suffer damage or destruction.

## Decoder Installation

- Connect the white wire to one of the headlight leads.
- Connect the yellow wire to one of the backup light leads.
- The green wire connects to the function output AUX1.
- The purple wire goes to the function output AUX2.
- The pink wire connects to the function output AUX3
- The turquoise wire connects to the function output AUX4
- You must connect the remaining wires of all bulbs and functions together to the blue wire. This pole may not have any connection to the chassis!

### 4.2.4.1. Overload protection

The function outputs of the LokSound Select decoders have electronic protection against overload and short circuit. The decoder keeps checking the sum of all function output currents. If the current is too high, the decoder will switch off the outputs. After about 1 second, the decoder tries to switch them on again. Should the current still be too high – perhaps due to a short circuit – the same procedure starts again. When using light bulbs (incandescent lamps) please note the following: they draw a very high “inrush current” when they are switched on, that becomes lower after a few moments. Therefore, it can happen with 12V bulbs that the headlights “flash” briefly during switch-on and then extinguish due to the overload protection of the decoder. It is important to install the correct bulbs.

### 4.2.4.2. Suitable light bulbs

Only install bulbs rated 16V or higher and with a nominal current, that does not exceed 50 mA. Many older models have 12V bulbs installed. They draw a high current, become very hot, and may cause damage to the locomotive. Replace them with 16V bulbs.

### 4.2.4.3. Using LEDs

#### 4.2.4.3.1. LokSound Select / LokSound Select micro

If LEDs are installed, then a resistor must be wired in series with the LEDs. It should have a rating of between 470 Ohms and 2.2 kOhms. Running the LEDs without this resistor will lead to their destruction! Unlike light bulbs, LEDs are polarity-sensitive. The minus (cathode) end of the LED is connected to the function output,

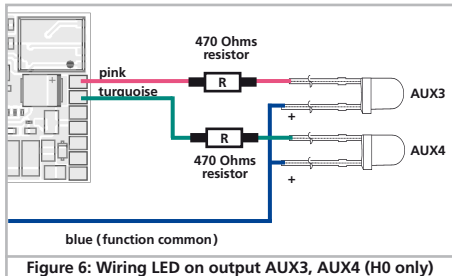

Figure 6: Wiring LED on output AUX3, AUX4 (H0 only)

the plus (anode) end is connected to the blue (function common) wire. Refer to figure 6 to see the details.



If you use LEDs, you should re-program the function output configuration to LED mode. This will make sure you get prototypical characteristics out of the LokSound Select. Refer chapter 5.2.6.2. for more details.

#### 4.2.4.3.2 LokSound Select Direct

On the Select Direct Board we have already added a resistor with 2.2k for each function output. This will result in a current between 8mA and 10mA suitable for most locomotives.

Thus you can directly connect your LEDs without thinking of resistor values. However, should you use bulbs consider the following:

First locate the appropriate soldering bridge on the Select Direct Board (see diagram above) for the output desired. Use a small amount of solder to connect the two soldering pads. This will bypass the installed 2.2k resistor.

If the bulbs to be used are less than 16V types, please add a resistor between the Select Direct and the bulbs.

# Decoder Installation

- Athearn: 2 - 1.5 Volt Bulbs 360-510Ohms (Front or rear lights)
- Athearn: 1 - 1.5 Volt Bulb 680-1K Ohm (Acc. Lights)
- Atlas: Resistors may already be attached to Factory LED's, you may be also bypass the Select Direct installed 2.2k resistors

## 4.2.5. Install the CAM

If you want to synchronize the steam exhaust chuff using a sensor, you have a little work to do. LokSound Select decoders support several types of sensors: Reed switches, Hall sensors and mechanical wipers. The most accurate result you will get when using a hall sensor IC in combination with (up to) four magnets.

If you want to use an external sensor, you need to configure the LokSound Select so that it will use the sensor input. By default, the LokSound Select is setup to use the computed exhaust chuff.

Set CV 57 to 0 in order to tell the Select to use the external sensor. Using CV 58, you can define how many sensor pulses the decoder has to receive before it generates a steam chuff. Set CV 58 = 1 to have a chuff triggered on each pulse the decoder receives from the sensor. Based on the type of sensor IC you use, this may result in double the amount of steam chuffs you want to have. Set CV 58 = 2 in such a case. For values of 3 and more every n trigger pulses the decoder counts will result in one steam chuff. This is useful for geared locomotives.

### 4.2.5.1. Hall sensor IC (H0 only)

A Hall sensor is an electronic circuit that responds to an alternating magnetic field similar to a reed switch. Hall sensors are easier to adjust since the distance between sensor and magnet is not critical. A commonly used hall sensor, which can be purchased via mail order is the TLE4905 by Siemens / Infineon. There are also many compatible devices on the market. The terminals have to be wired to the LokSound Select as shown in figure 7.

Place four miniature magnets on the inner side of the driving wheel in a way that the magnet will trigger the HALL IC each time it will pass the sensor IC.



For 3 cylinder locomotives or articulated engines, you may need to use even 6 or 8 magnets, depending on the cylinder configuration.

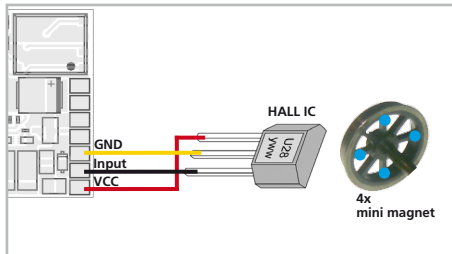

Figure 7: HALL IC wiring to the LokSound Select (H0 only)

### 4.2.5.2. Reed switch sensor (H0 only)

If you have troubles obtaining a hall sensor IC, you may also use a subminiature reed switch. These offer two pins only resulting in easier wiring. However, their sensitivity is not as good as hall IC

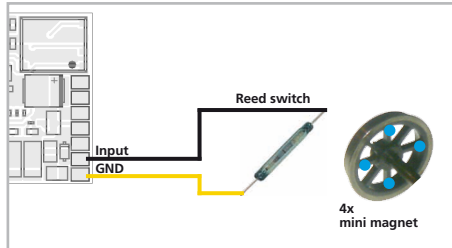

Figure 8: Reed switch wiring to LokSound Select (H0 only)

# Decoder Installation

sensors and stronger magnets may be needed in order to trigger these reed switches correctly.

## 4.3. Installing LokSound Select in a DCC-ready model

If your locomotive offers an NMRA-compatible 8-pin socket, then the wiring is much easier. Each LokSound Select of the second generation is shipped with a suitable NMRA compatible 8-pin plug directly soldered to the decoder wires.

For the first generation LokSound Select Decoder, ESU is providing a suitable wire harness as an option under ESU P/N 51953.

- Remove the dummy plug from the locomotive's socket and keep it in a suitable place for later use.
- Insert the plug of the decoder in such a way that pin 1 of the plug (this is the side with the red / orange wires) sits next to the corner of the socket that is usually marked with \*, +, • or 1. Please make sure that the pins are straight when inserting the plug.

**!** Do not rely on the assumption that the wires of the harness have to face in a certain direction: the only reliable reference is the marking of pin 1.

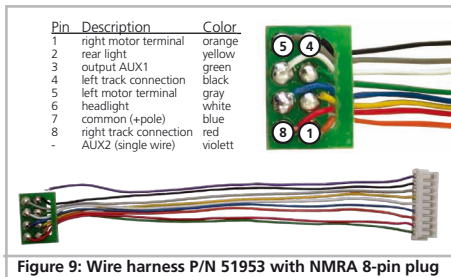

Figure 9: Wire harness P/N 51953 with NMRA 8-pin plug

## 4.4. Installing LokSound Select Direct

### 4.5. Connecting capacitors

On many older layouts, current pick up of locomotives is not very reliable. Therefore, power interruptions may cause a stop or jerky movement when the locomotive travels over turnouts at low speeds. This can be overcome with buffer capacitors (100 mF /25V or higher show the desired results). If desired you may connect them to the LokSound Select decoders.

**!** Soldering wires onto a decoder requires quality soldering equipment and experience. Our warranty does not cover damage caused by inappropriate soldering. Consider carefully if you really need that capacitor.

#### 4.5.1. All LokSound H0 and micro decoders

You can connect two larger capacitors as per the circuit in the upper half of figure 10. The capacitor is charged via a resistor (100 Ohms) thus preventing the digital system from interpreting the charging current as short circuit at the time of switch-on. The diode makes sure that the energy of the capacitor is fully available when required.

**i** Disconnect / remove the capacitor prior to programming with the ESU LokProgrammer!

#### 4.5.2. Optional "PowerPack"

You can solder a powerful energy buffer to all LokSound Select / LokSound Select micro decoders. In the lower half of figure 10 we show you how to do it. This „PowerPack“ allows your locomotive to keep running for 2 seconds without power.



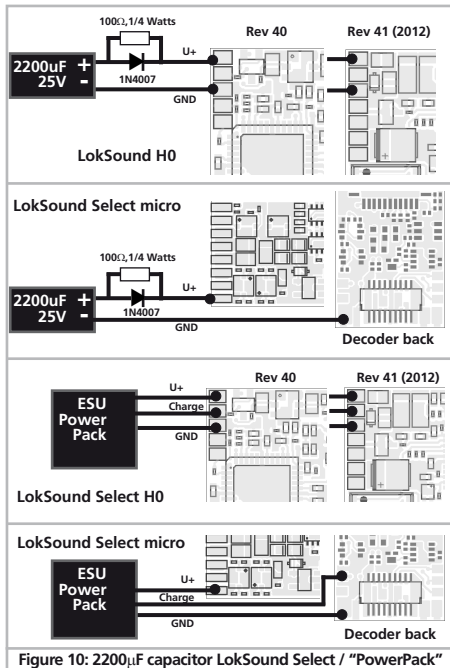

Figure 10: 2200µF capacitor LokSound Select / "PowerPack"

## 5. Decoder settings (programming)

Chapter 5 covers setting various parameters of the LokSound Select decoder. If you are not familiar with the handling of CVs please take the time to read these occasionally quite complex

instructions.

After an introduction into the world of parameters in chapter 5.1, we explain in the following section 5.2 how to change various parameters in DCC mode.

### 5.1. Basics of DCC programming

The hardware determines some features such as the number of function outputs as well as the maximum permitted current of the motor output and therefore they are not programmable. Nevertheless, there are plenty of possibilities to influence the behavior of the LokSound Select decoder by adjusting software-governed properties. There is at least one memory space within the decoder reserved for each adjustable parameter where numbers or letters can be stored.

You could visualize the storage spaces as index cards in a large file box. In order to enable you to find the right card again, they all have numbers and / or names outlining the properties of this particular card such as "locomotive address" or "maximum speed."

Then imagine that you can write information onto these cards. Adjusting the settings means nothing else but erasing one entry and replacing it with another. Moreover, you could do that at any time. However, you cannot write onto every card: some bits of information like the manufacturer's code are firmly encoded.

Thus, you can determine the content of the storage spaces in the decoder even during operation and of course, the decoder will follow the instructions. Via the procedure known as "Programming", you can enter the desired data into the storage spaces.

#### 5.1.1. Configuration variables (CV)

The LokSound Select decoders follow the CV concept developed in the US. CV stands for "Configuration Variable" and indicates

# Decoder settings

that the storage cells described above are not only variable but they also determine the behavior of the decoder.

## 5.1.2. Standardization in the NMRA

The NMRA (National Model Railroad Association) has defined which CVs determine certain parameters of a decoder. The DCC standard allocates fixed numbers for certain CVs (adherence is

obligatory). This greatly simplifies things for the user since decoders of most manufacturers comply with this standard and therefore dealing with CVs requires the same process with the same CV-numbers regardless of the manufacturer.

The DCC concept permits to enter numbers ranging from 0 to 255 into CVs. Each CV carries only one number.



While the position number is predetermined, the range of values may vary. Not all CVs must accept values ranging from 0 to 255. The permitted values for LokSound Select decoders are listed in the table in chapter 8, showing the most important available CVs.

## 5.1.3. Bits and Bytes

Most CVs contain numbers: CV 1 for instance contains the locomotive address. This can be any number between 1 and 127. While most CVs expect numbers to be entered, some others are rather like a “collection point” of various “switches”, that administer different functions in one CV (mainly “on” or “off”): CVs 29 and 49 are good examples: you must calculate the value for these CVs yourself. The value depends on which settings you want to program:

Have a look at the explanations for CV 29 in the table in chapter 8: firstly, decide which options should be active. The column “Value” has two numbers for each option. If the option is switched off, the value is 0. Otherwise, it is a number between 1 and 128. Add all the values for the respective options to arrive at the correct value for this CV.

Example: Let us assume you want to run trains with the ECoS in DCC mode with 128 speed steps. Analog detection should be active (because you also want to drive your locomotive in analog mode). All other options are not active. Therefore, you must write the value 6 in CV 29 ( $0 + 2 + 4 + 0 = 6$ ).

## 5.1.4. Programming methods

LokSound Select decoders support all NMRA programming modes as there are the programming track modes (Direct Mode, Register Mode, Paged Mode) and the mode for the main (“POM”, “Programming on the Main”).

### 5.1.4.1. Programming on the Main

Programming on the Main (also called “Operations Mode programming”) enables you to program your decoders comfortably without having to remove the locomotive from the layout. In this case, the command station talks directly to the decoder by using its locomotive address, for instance:

“Locomotive number 50, write the value 7 into CV 31!”. Thus knowing the locomotive address is a precondition. Unfortunately, you cannot read CV values using this mode.

### 5.1.4.2. Service Mode Programming

This programming mode usually requires the locomotive to be placed on a special programming track output of the command station. Only using the service track, you can read CV values and also reprogram the locomotive address without knowing the old address since the command station simply transmits the command “Write value 7 in CV 31!”. Each decoder receiving this command will execute it.



In order to be able to read back the CV values from your decoder, the motor terminals must be properly connected to the motor. The motor is used to produce the “feedback” current detected by the command station.

The LokSound Select does not need any programming track booster or similar circuitry.

## 5.1.5. Programming procedure using various DCC systems

As each DCC system is different, the procedure for changing a CV will vary depending upon the system. We are very sorry that we are unable to provide detailed instructions to cover every system on the market. We need to assume that you are familiar with your system. Please consult your DCC system manual for detailed specification. We tested the LokSound Select with almost every DCC system available on the market (as of mid of 2009), so there should not be any general problem.

## 5.1.6. Programming with the ESU LokProgrammer

The LokProgrammer 53450/53452 offers the easiest and most comfortable way of setting the CVs of the LokSound Select decoders: simply by a few mouse clicks on an MS-Windows® computer. The computer helps you look for the various CV numbers and values. More information is contained in the manual for the LokProgrammer.

You can access all properties of ESU decoders with the LokProgrammer. You even can erase the sound and download a new sound package. Please see our website for more details.

## 5.1.7. Resetting the CVs or starting over

Sometimes, something goes wrong and your LokSound Select may not respond as expected. Usually, this is caused by one or more CVs being programmed to the wrong value. All CV settings can be quickly reset to their factory default values:

- Write the value 8 into CV 8 by using either Service Mode or Programming on the Main
- Allow the decoder to power cycle (disable power, reapply power)
- After around 8 second, the LokSound Select should be reset to default values and listen to short address 3.

## 5.2. Setting up your LokSound Select

### 5.2.1. Step 1: Address Settings

Each LokSound Select decoder requires a definite address to be addressable for the central unit. Depending on the type of decoder and the digital system, there are several possibilities how to allocate addresses. The LokSound Select may be setup to listen to either the primary address (also called “short” address), which provides a range of 1 to 127 or the extended (“long”) address, which has a range of up to 9999. Based on your preferences and your command station’s capabilities, you may select either the primary address or the extended address for usage. Be aware that some DCC systems do not support the full range of available addresses. Bit 5 in CV 29 switches between short and long address. The decoder can only respond to one address at a time.

If CV 29, Bit 5 is cleared, the decoder listens to the primary address stored in CV 1.

If CV 29, Bit 5 is set, the decoder listens to the extended address stored in CV 17 AND CV 18.

#### 5.2.1.1. Primary Address

Normally you would control LokSound Select decoders with the short address that is stored in CV 1. In DCC mode, the permitted values range from 1 to 127. In order to enable the decoder to “listen” to the short address you must delete bit 5 in CV 29.

Some digital systems (e.g.: ROCO® Lokmaus2, Lenz® digital plus, Lenz compact) only support the values 1 – 99 as short addresses.

#### 5.2.1.2. Extended Address

You can also operate LokSound Select decoders with extended addresses (4-digit addresses). The supported values range from 128 – 10239. The extended address is stored in CVs 17 and 18. You must activate the usage of the extended address by setting bit 5 in CV 29.

If you want to use your LokSound Select with the extended address it is practical to program this address directly with your digital

## Decoder settings - speed curve

system: most modern digital systems (e.g.: ESU ECoS, Bachmann E-Z Command® Dynamis®) have a menu for programming long addresses. The command station not only programs CV 29 correctly but also assures the correct storage of the values for the long address in CV 17 and 18.

**i** If you want to enter the long address manually in CV 17 and 18 please refer to chapter 9.1.

Both the primary and the extended address may be changed at any time using service mode (on the programming track).

Some DCC systems (such as ESU ECoS, ESU Navigator, Bachmann® Dynamis®) will allow the decoder address to be modified using Programming On The Main. LokSound Select will accept the programming commands, but the following restrictions apply:

- If the decoder's primary address is enabled, the decoder will accept a new primary address and follow this immediately.
- If the decoder's primary address is enabled, the decoder will accept a new secondary address (write of CV 17, 18)
- If the decoder's extended address is enabled, the decoder will only accept a new primary address. You cannot change an extended address to another number using Programming On the Main.

### 5.2.2. Step 2: Configuring the decoders behavior

#### 5.2.2.1. Acceleration / Deceleration

Acceleration and brake time can be set independently of each other. Therefore, you could for instance program a short acceleration and a much longer brake time.

The time for accelerating from 0 to maximum speed is adjusted in CV 3 while deceleration is set in CV 4. Permitted values are 0 (no delay) to 63.

The times set in these CVs work speed dependant. Therefore, the acceleration distance and the brake distance are longer at high speeds. In other words, the faster the locomotive moves, the longer is the distance until it stops.

**i** For information on how to set a brake distance independently of the speed refer to chapter 5.2.8.

#### 5.2.2.2. Starting voltage, Max and Medium Speed

LokSound Select decoders know 255 speed steps internally. They can be adapted to the characteristic of the locomotive and allocated to the actual available speed steps (14, 28, or 128):

The NMRA defined two options to facilitate this:

Motor characteristic via CV 2, 5, and 6 (Fig. 5): enter the start voltage in CV 2 and the maximum speed in CV 5. CV 6 corresponds with the speed at a medium speed step. Thus, you can define a kink in the speed curve. This mode is active if bit 4 = 0 in CV 29. The values of the start, mid and maximum speed are dependent on each other. Selecting a mid speed that is lower than the start speed or higher than the maximum speed could lead to some erratic driving performance. Therefore always adhere to the principle: start voltage < mid speed < maximum speed.

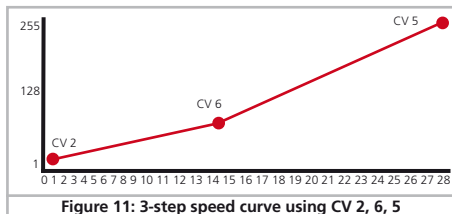

Figure 11: 3-step speed curve using CV 2, 6, 5

## Decoder settings - Consist function control

### 5.2.2.3. Speed curve

You may also define your own speed curve: simply enter the desired values in CVs 67 to 94 (also refer to Fig. 6). The decoder will superimpose these 28 values onto the real speed steps. Thus, you can optimally adapt the driving performance to your locomotive. This mode is only active if bit 4 in CV 29 is set.



We recommend using the ESU LokProgrammer for easy and comfortable programming. When this mode is active, the settings in CV 2, CV 5, and CV 6 have no influence.

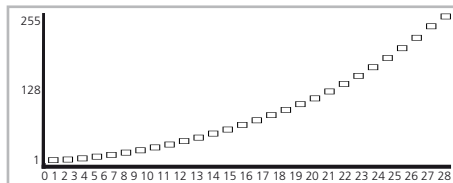

Figure 12: speed curve using CV 67–94

### 5.2.2.4. Adjust forward and reverse trim

There are two more CVs for adjusting the forward and reverse speeds. CV 66 is the Forward Trim, CV 67 controls the Reverse Trim.

These CVs multiply all data points in the speed table (either CV 67 to 94 or CV 2,5,6) by a factor of  $n/128$  (where  $n$  is the value stored in the CV). This results the overall speed curve to be adjusted up or down without the need to adjust the speed table data points again.

The CVs can hold values between 0 and 255. A trim value  $> 128$  will result in a higher speed, a trim value  $< 128$  will result in a lower speed. A value of 128 maintains the original scaling factor of 1 and will therefore have no influence in the speed curve.

Using different values for the forward and the reverse trim will

result in different speed for forward and reverse. This is useful for steam locomotives, since their maximum allowed speed during backup was often restricted.

### 5.2.2.5. Switching mode

The default setting for the switching mode is F7. It reduces the speed to about 50%. Thus, you have smoother control of your locomotive in the lower speed ranges, which is important for switching, particularly in the 14-speed-step mode.

### 5.2.2.6. Analog DC mode

The LokSound Select can also be used on conventional layouts. By default, this option is enabled. If you don't want to use the LokSound Select on conventional DC layouts, please disable the analog mode by clearing bit 2 of CV 29. Disabling this mode is useful if you plan to use some automatic braking modes. Refer to chapter 5.2.8.1. for details

### 5.2.3. Step 3: Configuring for Consist Operation

LokSound Select decoders support advanced consisting, which are controlled by 3 related CVs: The Consist Address is stored in CV 19. CV 21 and CV 22 control how the functions are enabled while the locomotive is part of a consist.

A consist is a group of locomotives that are set up to respond to throttle settings as a single unit. This is useful to run double-headed steam trains or multi-unit diesel lash-ups. The specific consist address allow the decoder to listen to a specific address assigned to the consist without the need to change the primary or extended address. Further, CV 21 and CV 22 allow each locomotive to run in the consist but still maintain individual control on some or all of the functions. For example, you may decide to blow the horn on the lead engine only.

First of all, you should define a specific address for your consist. This address must be in the range of 1 – 127. Using this address on your throttle will control the consist – after setup.

First, write the consist address in CV 19 of all locomotives you want to consist. If one locomotive is facing backward, you may

## Decoder settings - Back - EMF

program CV 19 with the same value plus 128. This will maintain the same final direction of all locomotives.



To disable the consist address, reprogram CV 19 back to 0. While the consist address is set, the decoder will continue to follow instructions sent to its primary (extended) address except for speed and direction commands.

### 5.2.3.1. Consist Function Control

CV 21 and CV 22 allow you to define how each individual engine responds to function commands sent to the consist address when the consist address is active (CV 19>0). CV 21 controls the function buttons F1–F8, CV 22 controls the F0 function (separately for Forward and Reverse operation) and the function keys F9–F12.

#### Consist Function Control 1

CV #	F1	F2	F3	F4	F5	F6	F7	F8
21	1	2	4	8	16	32	64	128

#### Consist Function Control 2

CV #	F0(f)	F0(r)	F9	F10	F11	F12		
22	1	2	4	8	16	32		

If you want to control a function using the consist address, you need to set the corresponding bit in CV 21, CV 22. If you want to control the function using the primary (secondary) address, you need to clear the corresponding bit.

- The values of CV 21, CV 22 are active only while consist mode is active
- Each locomotive in the consist may need different value sets, depending on what you want to accomplish.

### 5.2.4. Step 4: Setting up the Motor Control

5th generation load compensation enables LokSound Select decoders to execute precise motor control. Even with the default settings, most locomotives run perfectly. If you are satisfied with the running characteristics of your engine, you may skip this chapter.

### 5.2.4.1. Adjusting Back-EMF

Should you find after programming and doing the initial test that the locomotive does not run smoothly particularly at low speed or that the locomotive jerks a little after having stopped or if you are simply unsatisfied with the driving performance, then you should adjust the load compensation of your LokSound Select decoder.

Due to the large number of different types of motors and drive systems there is no single setting that suits all. Load compensation can be influenced with 4 CVs (CV 52, CV 53, CV 54, CV 55).

Firstly, check if the irregular performance is due to any mechanical faults. Bent driving rods are one common cause. When you turn off load compensation as shown in chapter 5.2.4.5. and the problem persists then it is likely there is a mechanical fault.

### 5.2.4.2. Parameters for frequently used motors

Usually, your locomotive should work fine with the default settings of the LokSound Select decoder. However, in some rare cases, the running may be jerky and uneven. This is often the case when using motors without flywheel or very old motors ("non"-can motors).

We have listed the correct settings for some common motors in the following table. If a motor is missing, it means either that the default settings produce good results or that we have not yet sufficient experience about these motors. Set the suitable values and test-drive your locomotive.

Motor type	CV 52	CV 53	CV 54	CV 55
Can motor with flywheel ( default ) This should work well with Athearn®, Kato®, Atlas® and similar engines	32	140	48	32
Coreless motors ( e.g. Maxxon )	16	140	48	20
Can motors without flywheel	32	140	80	50

### 5.2.4.3. Automatic Adjustment

LokSound Select decoders have an Automatic Motor Tuning Feature. This feature will automatically adjust the Back-EMF in most cases. This is not meant to be a “cure all” solution. This will only get the settings close. There still may need to be some manual adjustments made.

In order to use this automatic adjustment you will first need to set CV 54 to a value of 0. Then put your locomotive on the layout and activate F1. Be sure to have plenty of clear space ahead of your locomotive. Your locomotive will quickly take off at full speed and gradually slow down to a stop while reading the motor responses. This will automatically set the load compensation in CVs 52, CV 53, CV 54, and CV 55. From here you can make any other manual adjustments if needed.

### 5.2.4.4. Manual adjustment

Unfortunately, the motors available in the market have considerable variations due to tolerances. This is even true for the same type. Therefore, LokSound Select decoders enable you to adapt the Back-EMF control. If the recommended values above do not lead to acceptable results, you can further optimize them.



However, before doing this you must make sure that there are no capacitors wired between the motor terminals and the chassis. The commutator of the motor must be clean and the drive system should run freely. The wheel contacts and other contact plates of the locomotive must also be clean and make reliable contact.

#### 5.2.4.4.1. Parameter “K”

Parameter “K”, stored in CV 54, influences how strongly load control will affect the driving performance. The higher the value, the more the load control will respond to any changes and try to adjust the revs of the motor.

Parameter “K” needs adjustment if the locomotive runs unevenly (jerks) in speed step 1.

Reduce the value of CV 54 by 5 and test-run the locomotive to see if there are any improvements. Repeat these steps until the locomotive runs smoothly at speed step 1.



With some motors, it may be necessary to set the starting voltage (CV 2) to a value between 4 and 6 in order to arrive at good results.

#### 5.2.4.4.2. Parameter “I”

Parameter “I”, stored in CV 55 provides important information to the decoder on how much inertia the motor has. Motors with large flywheels naturally have more inertia than smaller ones or coreless motors.

Adjust parameter “I” if the locomotive jerks somewhat just before it stops or „jumps“ at lower speeds (lower third of the speed step range) or simply does not run smoothly.

- Reduce the value by 5 starting with the default value for motors with very small or no flywheels.
- Increase the value by 5 starting with the default value for motors with large flywheels.

Test again and repeat this procedure until you arrive at the desired result.

# Decoder settings - LokSound Select Diesel Function mapping table

Function Button	Physical outputs								Logic Functions #1							Logic Functions #2				
	CV 32	Control CV	Head Light	Backup Light	AUX1	AUX2	AUX3 (HO only)	AUX4 (HO only)	CV 32	Control CV	Acceleration	Switching Mode	Dynamic Brake	Dimmer	Railroad Crossing	CV32	Control CV	Manual Notch up	Manual Notch down	Doppler Effect
F0 Forward	2	266	1	2	4	8	16	32	2	268	1	2	4	64	128	2	269	2	4	32
F0 Backup	2	282	1	2	4	8	16	32	2	284	1	2	4	64	128	2	285	2	4	32
F1	2	298	1	2	4	8	16	32	2	300	1	2	4	64	128	2	301	2	4	32
F2	2	314	1	2	4	8	16	32	2	316	1	2	4	64	128	2	317	2	4	32
F3	2	330	1	2	4	8	16	32	2	332	1	2	4	64	128	2	333	2	4	32
F4	2	346	1	2	4	8	16	32	2	348	1	2	4	64	128	2	349	2	4	32
F5	2	362	1	2	4	8	16	32	2	364	1	2	4	64	128	2	365	2	4	32
F6	2	378	1	2	4	8	16	32	2	380	1	2	4	64	128	2	381	2	4	32
F7	2	394	1	2	4	8	16	32	2	396	1	2	4	64	128	2	397	2	4	32
F8	2	410	1	2	4	8	16	32	2	412	1	2	4	64	128	2	413	2	4	32
F9	2	426	1	2	4	8	16	32	2	428	1	2	4	64	128	2	429	2	4	32
F10	2	442	1	2	4	8	16	32	2	444	1	2	4	64	128	2	445	2	4	32
F11	2	458	1	2	4	8	16	32	2	460	1	2	4	64	128	2	461	2	4	32
F12	2	474	1	2	4	8	16	32	2	476	1	2	4	64	128	2	477	2	4	32
F13	2	490	1	2	4	8	16	32	2	492	1	2	4	64	128	2	493	2	4	32
F14	2	506	1	2	4	8	16	32	2	508	1	2	4	64	128	2	509	2	4	32
F15	3	266	1	2	4	8	16	32	3	268	1	2	4	64	128	3	269	2	4	32
F16	3	282	1	2	4	8	16	32	3	284	1	2	4	64	128	3	285	2	4	32
F17	3	298	1	2	4	8	16	32	3	300	1	2	4	64	128	3	301	2	4	32
F18	3	314	1	2	4	8	16	32	3	316	1	2	4	64	128	3	317	2	4	32
F19	3	330	1	2	4	8	16	32	3	332	1	2	4	64	128	3	333	2	4	32
F20	3	346	1	2	4	8	16	32	3	348	1	2	4	64	128	3	349	2	4	32
F21	3	362	1	2	4	8	16	32	3	364	1	2	4	64	128	3	365	2	4	32

Figure 13: Function mapping table (Diesel)



		Sound Functions #1										Sound Functions #2									
Volume Control	Shift Mode	CV 32	Control CV	Prime Mover	Horn	Bell	Coupler	Dynamik Brake	Compressor	Fan	CV 32	Control CV	Detector	Crossing Comm.	RailClank	Brake Set Release	Sanding	Short Air let off	Pop valve	Short Airhorn	
64	128	2	270	1	4	8	16	32	64	128	2	271	1	2	4	8	16	32	64	128	
64	128	2	286	1	4	8	16	32	64	128	2	287	1	2	4	8	16	32	64	128	
64	128	2	302	1	4	8	16	32	64	128	2	303	1	2	4	8	16	32	64	128	
64	128	2	318	1	4	8	16	32	64	128	2	319	1	2	4	8	16	32	64	128	
64	128	2	334	1	4	8	16	32	64	128	2	335	1	2	4	8	16	32	64	128	
64	128	2	350	1	4	8	16	32	64	128	2	351	1	2	4	8	16	32	64	128	
64	128	2	366	1	4	8	16	32	64	128	2	367	1	2	4	8	16	32	64	128	
64	128	2	382	1	4	8	16	32	64	128	2	383	1	2	4	8	16	32	64	128	
64	128	2	398	1	4	8	16	32	64	128	2	399	1	2	4	8	16	32	64	128	
64	128	2	414	1	4	8	16	32	64	128	2	415	1	2	4	8	16	32	64	128	
64	128	2	430	1	4	8	16	32	64	128	2	431	1	2	4	8	16	32	64	128	
64	128	2	446	1	4	8	16	32	64	128	2	447	1	2	4	8	16	32	64	128	
64	128	2	462	1	4	8	16	32	64	128	2	463	1	2	4	8	16	32	64	128	
64	128	2	478	1	4	8	16	32	64	128	2	479	1	2	4	8	16	32	64	128	
64	128	2	494	1	4	8	16	32	64	128	2	495	1	2	4	8	16	32	64	128	
64	128	2	510	1	4	8	16	32	64	128	2	511	1	2	4	8	16	32	64	128	
64	128	3	270	1	4	8	16	32	64	128	3	271	1	2	4	8	16	32	64	128	
64	128	3	286	1	4	8	16	32	64	128	3	287	1	2	4	8	16	32	64	128	
64	128	3	302	1	4	8	16	32	64	128	3	303	1	2	4	8	16	32	64	128	
64	128	3	318	1	4	8	16	32	64	128	3	319	1	2	4	8	16	32	64	128	
64	128	3	334	1	4	8	16	32	64	128	3	335	1	2	4	8	16	32	64	128	
64	128	3	350	1	4	8	16	32	64	128	3	351	1	2	4	8	16	32	64	128	
64	128	3	366	1	4	8	16	32	64	128	3	367	1	2	4	8	16	32	64	128	

(Default values are highlighted)

# Decoder settings - LokSound Select Steam Function mapping table

Function Button	Physical outputs								Logic Functions #1							Logic Functions #2				
	CV 32	Control CV	Head Light	Backup Light	AUX1	AUX2	AUX3 (HO only)	AUX4 (HO only)	CV 32	Control CV	Acceleration	Switching Mode	Dynamic Brake	Dimmer	Railroad Crossing	CV32	Control CV	Manual Notch up	Manual Notch down	Doppler Effect
F0 Forward	2	266	1	2	4	8	16	32	2	268	1	2	4	64	128	2	269	2	4	32
F0 Backup	2	282	1	2	4	8	16	32	2	284	1	2	4	64	128	2	285	2	4	32
F1	2	298	1	2	4	8	16	32	2	300	1	2	4	64	128	2	301	2	4	32
F2	2	314	1	2	4	8	16	32	2	316	1	2	4	64	128	2	317	2	4	32
F3	2	330	1	2	4	8	16	32	2	332	1	2	4	64	128	2	333	2	4	32
F4	2	346	1	2	4	8	16	32	2	348	1	2	4	64	128	2	349	2	4	32
F5	2	362	1	2	4	8	16	32	2	364	1	2	4	64	128	2	365	2	4	32
F6	2	378	1	2	4	8	16	32	2	380	1	2	4	64	128	2	381	2	4	32
F7	2	394	1	2	4	8	16	32	2	396	1	2	4	64	128	2	397	2	4	32
F8	2	410	1	2	4	8	16	32	2	412	1	2	4	64	128	2	413	2	4	32
F9	2	426	1	2	4	8	16	32	2	428	1	2	4	64	128	2	429	2	4	32
F10	2	442	1	2	4	8	16	32	2	444	1	2	4	64	128	2	445	2	4	32
F11	2	458	1	2	4	8	16	32	2	460	1	2	4	64	128	2	461	2	4	32
F12	2	474	1	2	4	8	16	32	2	476	1	2	4	64	128	2	477	2	4	32
F13	2	490	1	2	4	8	16	32	2	492	1	2	4	64	128	2	493	2	4	32
F14	2	506	1	2	4	8	16	32	2	508	1	2	4	64	128	2	509	2	4	32
F15	3	266	1	2	4	8	16	32	3	268	1	2	4	64	128	3	269	2	4	32
F16	3	282	1	2	4	8	16	32	3	284	1	2	4	64	128	3	285	2	4	32
F17	3	298	1	2	4	8	16	32	3	300	1	2	4	64	128	3	301	2	4	32
F18	3	314	1	2	4	8	16	32	3	316	1	2	4	64	128	3	317	2	4	32
F19	3	330	1	2	4	8	16	32	3	332	1	2	4	64	128	3	333	2	4	32
F20	3	346	1	2	4	8	16	32	3	348	1	2	4	64	128	3	349	2	4	32
F21	3	362	1	2	4	8	16	32	3	364	1	2	4	64	128	3	365	2	4	32

Figure 14: Function mapping table (Steam)

		Sound Functions #1										Sound Functions #2									
Volume Control	Shift Mode	CV 32	Control CV	Prime Mover	Horn	Bell	Coupler	Dynamo	Airpump	Blower	CV 32	Control CV	Water injector	Crossing Comm.	RailClank	Brake Set Release	Sanding	Oil injector	Shoveling coal	Short Whistle	
64	128	2	270	1	4	8	16	32	64	128	2	271	1	2	4	8	16	32	64	128	
64	128	2	286	1	4	8	16	32	64	128	2	287	1	2	4	8	16	32	64	128	
64	128	2	302	1	4	8	16	32	64	128	2	303	1	2	4	8	16	32	64	128	
64	128	2	318	1	4	8	16	32	64	128	2	319	1	2	4	8	16	32	64	128	
64	128	2	334	1	4	8	16	32	64	128	2	335	1	2	4	8	16	32	64	128	
64	128	2	350	1	4	8	16	32	64	128	2	351	1	2	4	8	16	32	64	128	
64	128	2	366	1	4	8	16	32	64	128	2	367	1	2	4	8	16	32	64	128	
64	128	2	382	1	4	8	16	32	64	128	2	383	1	2	4	8	16	32	64	128	
64	128	2	398	1	4	8	16	32	64	128	2	399	1	2	4	8	16	32	64	128	
64	128	2	414	1	4	8	16	32	64	128	2	415	1	2	4	8	16	32	64	128	
64	128	2	430	1	4	8	16	32	64	128	2	431	1	2	4	8	16	32	64	128	
64	128	2	446	1	4	8	16	32	64	128	2	447	1	2	4	8	16	32	64	128	
64	128	2	462	1	4	8	16	32	64	128	2	463	1	2	4	8	16	32	64	128	
64	128	2	478	1	4	8	16	32	64	128	2	479	1	2	4	8	16	32	64	128	
64	128	2	494	1	4	8	16	32	64	128	2	495	1	2	4	8	16	32	64	128	
64	128	2	510	1	4	8	16	32	64	128	2	511	1	2	4	8	16	32	64	128	
64	128	3	270	1	4	8	16	32	64	128	3	271	1	2	4	8	16	32	64	128	
64	128	3	286	1	4	8	16	32	64	128	3	287	1	2	4	8	16	32	64	128	
64	128	3	302	1	4	8	16	32	64	128	3	303	1	2	4	8	16	32	64	128	
64	128	3	318	1	4	8	16	32	64	128	3	319	1	2	4	8	16	32	64	128	
64	128	3	334	1	4	8	16	32	64	128	3	335	1	2	4	8	16	32	64	128	
64	128	3	350	1	4	8	16	32	64	128	3	351	1	2	4	8	16	32	64	128	
64	128	3	366	1	4	8	16	32	64	128	3	367	1	2	4	8	16	32	64	128	

(Default values are highlighted)

## Decoder settings – Function mapping

### 5.2.4.4.3. Reference Voltage

In CV 53, you set the EMF reference voltage generated by the motor at maximum revs. This parameter may have to be adapted subject to the track voltage and the efficiency of the motor.

If the locomotive reaches maximum speed when the throttle is set to about a third and the top third of the throttle has no influence on the speed, then you should reduce the value of CV 53. Reduce the value by 5 – 8 and test the locomotive again. Repeat this process until the locomotive just reaches its maximum speed when the throttle is fully open.

### 5.2.4.4.4. Slow speed amplifier

Using CV 52, you can adjust the slow speed running characteristics used for speed step 1. If you find that the locomotive is not running smooth at very low speed, you may try to adjust this value. Some “trial and error” will be needed to find correct values for your motor.

### 5.2.4.4.5. Turning off Load compensation

Occasionally it may be beneficial to turn off load control; simply delete bit 0 in CV 49.

### 5.2.4.4.6. Dynamic Drive control: Up and down the hill

Dynamic Drive Control (DCC) enables you to adapt load control, as you may desire. Full control over the entire speed range (constant speed) is not always prototypical. Therefore you can set the degree to which load control will be effective between 0 (no load control) and 100% (load compensation over the full range),

At low speeds it is advisable to have 100% load compensation in order to prevent the locomotive from “getting stuck” or from “running away” without any load. The impact of load control should recede with increasing speed in order to have the full “unharnessed” power of the motor available when the throttle is fully open. Thus, the locomotive will respond to certain changes in the main line such as gradients. The locomotive will run faster downhill and become slower climbing the hill.

The desired degree of load control influence is set in CV 56.



It is particularly meaningful to reduce the influence of load control whenever you run consists. This allows for better driving properties of all locomotives in the consist.

### 5.2.5. Step 5: Function mapping

Function Mapping allows the LokSound Select decoder to be reconfigured so that sound effects and function outputs can respond to the function key inputs you prefer if you are unhappy with the default function mapping as shown in chapter 3.1. This may be the case if you own an older DCC system with less than 13 function keys and need to reassign the keys to be able to access at least the most important functions.

In contrast to the poor NMRA function mapping, ESU uses an advanced function mapping which allows mapping up to 22 functions for the LokSound Select decoder. However, this flexibility means that we need a large bunch of CVs in order to hold all the information. The problem is that the NMRA did not allow enough CVs. But there is a solution for this problem called “Indexed CV access”.

#### 5.2.5.1. Index CV access

The CVs ranging from 257–511 have a special meaning on the LokSound Select decoder: They are “indexed”. This means, that the meaning of any of these CVs can change depending on the value of the so-called “Index register”. By changing the value of the index register, also the meaning and the value of the CV itself is changed. This method allows us to use every CV multiple times and results in an extension of available CVs.

The index register is CV 32. It can hold the values 0,1,2 or 3. You can write the index register at any time using any programming method. Based on the value of CV 32, the meaning of CV 257–511 is changed.



The meaning of all other CVs (1–256) is not influenced by the value of the index register.

So before you read or write any of the CVs located in the range of 257 – 511, please make sure that you set the index register to the correct value first.

# Decoder settings - Function mapping

## 5.2.5.2. Function Mapping table

Please refer to figure 13/14 on the previous pages to have an overview of the possible options. Each function key can control more than one output. There are 4 types of outputs

- Physical outputs: There are six real outputs on the LokSound Select decoder. You can use them for lighting effects or activating smoke units (on steam decoders) or other things.
- Logical functions: Such as Dynamic brake mode, Switching Mode and so on. These functions have a direct influence on the decoders behavior.
- Modifier Functions: Functions such as "Shift mode" or "Full brightness" are used in combination with other functions or influence the behavior of functions.
- Sound functions: These functions play-back the mentioned sound. An output can also be controlled by more than one function key. The keys are "logical oRed" together. This means that either key will turn an output on, but to turn off the output again, all function keys have to be turned off, too.

To determine the correct CV values,

- Find the column in the table corresponding to the output (or sound effect) you wish to control.
- Identify the line corresponding to the function key you wish to use for the selected output.
- Note the numbers at the intersection of the line and the column you have selected.
- Program the Control CV listed left aside the noted number. Before you write this CV, make sure the index register CV 32 has the value shown left aside the Control CV number

For each function key, there are 5 control CVs. After you programmed the desired CV, you may set the other 4 CVs to zero to avoid unintentionally altering other outputs.

Example: Swapping the Bell and the Coupler clank functions

On some DCC throttles the Bell control is labeled on function key F3 instead of F1. Luckily, we can use function mapping to assign the Bell to F3. However, initially F3 controlled the coupler clank

sound which we will now re-assign to F1.

First, we want to assign the Bell to F3. Using the function mapping table, you can find that you should set CV 334 to the value 8: Just follow the line for F3 until it intersects with the column for "Bell sound". Make sure that CV 32 is set to "2" before you perform the change.

Next, re-assign F1 to the coupler clank sound. We find that the responsible CV for doing so is CV 302. We also find that we must set CV 302 to value 16.

## 5.2.6. Step 6: Configuring the function outputs

LokSound Select decoders have six physical function outputs. Each can be set for a variety of effects such as dimmer, mars lights etc. In addition, each output can be combined with logical functions such as grade crossing logic to automatically activate the selected lighting effect when you enable the air horn.



The function buttons ("F buttons") of your command station or throttle activate the function outputs.

Generally, F0 is the lighting button, while we count the remaining buttons from F1 upwards.

### 5.2.6.1. Available lighting effects

Each output offers the choice of 12 different lighting effects useful for diesel engines. Most effects are primarily warning beacons.

DIMMABLE HEADLIGHT: The function acts as normal On/Off output. If the output is on, the brightness will be reduced to about 50% if the dimmer function is on.

DIMMABLE HEADLIGHT WITH FADE IN / OUT: The function acts as an On/Off output, but the brightness is faded in / out. This is useful for very old engines. If the output is on, the brightness will be reduced to about 50% if the dimmer function is on.

SINGLE STROBE: This is a single strobe light (short flashing) output. The frequency can be adjusted.

DOUBLE STROBE: This will result in two short flashes. The frequency can be adjusted.

## Decoder settings - Physical output light effect options

**ROTARY BEACON:** This effect should simulate a revolving reflector and bulb assignment of a very popular warning beacon atop many diesels of the 60's and 70's.

**PRIME STRATOLIGHT:** This is the more modern version of the Rotary beacon.

**DITCH LIGHT TYPE 1:** The ditch light type 1 will revert to a steady On state when it is not flashing.

**DITCH LIGHT TYPE 2:** The ditch light type 2 will revert to Off state when it is not flashing.



Ditch light type 1 and 2 behave the same, if the Crossing function is not enabled.

**OSCILLATING HEADLIGHT:** The oscillating headlight uses a moving reflector to sweep the headlight beam in a circular motion.

**FLASH LIGHT:** This will result in a flashing light. The frequency can be adjusted.

**MARS LIGHT:** This effect simulates the sweeping pattern of this well-known warning beacon

**GYRA LIGHT:** The Gyra Light is similar to the Mars Light, but is slower in motion.

### 5.2.6.2. Modifying the lighting effect

LokSound Select provides 3 CVs for each physical output, which defines their behavior.

**Mode Select:** Defines which effect you want to have for these customers

**Brightness:** Defines the brightness of each individual function output

**Special function:** Defines some further modes for each function output.

Have a look at figure 15 to see how this works.

Light effect	Mode Select	Brightness	Special function					
			Phase Select	Grade XING	Rule 17 Fw	Rule 17 Rev	Dimmer	LED Mode
Dimmable headlight	1	0-31	1	2	4	8	16	128
Dimmable headlight (fade in/out)	2	0-31	1	2	4	8	16	128
Firebox	3	0-31	1	2			16	128
Smart Firebox	4	0-31	1	2			16	128
Single Strobe	3	0-31	1	2	4	8	16	128
Double Strobe	4	0-31	1	2			16	128
Rotary Beacon	7	0-31	1	2			16	128
Strato Light	8	0-31	1	2			16	128
Ditch Light type 1	9	0-31	1	2			16	128
Ditch Light type 2	10	0-31	1	2			16	128
Oscillating Headlight	11	0-31	1	2			16	128
Flash Light	12	0-31	1	2			16	128
Mars Light	13	0-31	1	2			16	128
Gyra Light	14	0-31	1	2			16	128
FRED	15	0-31	1	2			16	128

Figure 15: Physical output light effect options and Special Functions

## Decoder settings - Physical output light effect options

We should explain this table in more detail:

**Mode select:** Defines the desired lighting effect.

**Brightness:** Each output can be set to any desired brightness level in 32 steps.

The special functions are additional functions you could add to each output.

**Phase Select:** Alters the timing of the effect so that it is 180 degree out of phase with other effects. This allows you to create alternate blinking. It is used for ditch lights mainly.

**Grade crossing:** Causes the lighting effect to become active only when the global flag "Grade crossing enable" is set AND the corresponding function key is ON (Usually, this flag will be set when the air horn is sounding). The most typical use of this function will be the ditch lights. Grade crossing logic can be used with any of the light effects. The strato light, ditch light type 1, Oscillating head lights, Mars Light or Gyra Light will change to a steady on state, Strobe and Double Strobe, Rotary Beacon, Ditch Light Type II and the Flash Light will revert to a steady off state if the Grade crossing logic is not enabled.

**Rule 17 Forward:** Applicable only if the output is set to either "Dimmable headlight" or "Dimmable headlight with fade in / out". Causes the effect to be dimmed to around 60% of the set brightness, if the locomotive is stopped. When the engine is running forward, the output will be set to the desired brightness level.

**Rule 17 Reverse:** Applicable only if the output is set to either "Dimmable headlight" or "Dimmable headlight with fade in / out". Causes the effect to be dimmed to around 60% of the set brightness, if the locomotive is stopped. When the engine is running in reverse direction, the output will be set to the desired brightness level.

**Dimmer:** Causes the output to be dimmed to around 60% of the defined brightness, if the global flag "Dimmer" is set. Usually, this flag will be set if the F9 key is pressed.

**LED mode:** The LokSound Select's outputs are pre-set to be used with incandescent bulbs. However, because of their differences in brightness characteristics, some lighting effects will not look prototypical if you use LEDs. If you wire LEDs on the output, you should set the LED compensation mode bit in order to get satisfying characteristics.

For each physical output, the three controlling CVs are defined as follows:

Physical Output	Mode Select CV	Brightness CV	Special function CV
Headlight	259	262	263
Backup light	267	270	271
AUX1	275	278	279
AUX2	283	286	287
AUX3 (H0 only)	291	294	295
AUX4 (H0 only)	299	302	303



Please set index register CV 32 to 0 before changing any of the above CVs.

## Decoder settings - Sound options

In order to set each output, you should proceed as follows:

1. From the figure 12 on the previous page, select the value for the Mode Select CV.
2. Compute the value for the Special Function CV by adding the values you can find in figure 13 below the corresponding special function.
3. Define the value for the desired brightness.
4. Write the values into the CV corresponding to the appropriate function output.

Repeat these steps for all 6 function outputs you want to configure.

**Example:** Double Strobe with LEDs on AUX4

We want to set up AUX4 to create a Double strobe output. We want to use an LED.

1. Using figure 13, we find that the Mode Selection CV must be set to 4.
2. We find out that for LED compensation mode, we should set the Special function CV to 128.
3. We want to have a brightness level of 25.
4. Using the table on the left side of this page, we find that the Mode Select CV for AUX4 is 299. We set CV 299 = 4. We also find that the brightness CV is 302 and set it to 25. Finally, the Special function CV for AUX4 is 303 and needs to be set to 128.

### 5.2.6.3. Grade Crossing holding time

You can define the time the grade crossing logic is still active after the air horn key is released. The desired value must be stored in CV 132. The value of CV 132 multiplied with 0.0625 seconds defines the time. The default value 80 results in 5.2 seconds.

### 5.2.6.4. Flash Rate

You can also set the flash rate for all lighting effects. All effects will flash or strobe at the same rate. The desired value should be stored in CV 112. The value of CV 112 multiplied with 0.0625 seconds defines the flash rate. The default value 30 results in 1.875 seconds.

### 5.2.7. Step 7: Modifying the Sound Effects

The LokSound Select allows you to adjust the sound in a way that suits your preferences. In particular, the LokSound Select decoder allows you to select from up to 4 prime mover sounds stored in the flash memory, to select between 15 air horns and between 2 bells.

Your selection of Prime Mover sound, air horn and bell is stored in CV 48. To compute the value for CV 48, just follow the instructions below.

#### 5.2.7.1. Air horn / whistle selection

Each LokSound Select decoder offers the following air horns:

#### Diesel Decoders

Air horn name	CV 48 value
Airhorn Nathan K5LA	0
Airhorn Nathan K3	1
Airhorn Nathan M5	2
Airhorn Nathan P3	3
Airhorn Nathan P5A	4
Airhorn Leslie S-2B	5
Airhorn Leslie A200	6
Airhorn Leslie S3	7
Airhorn Leslie S5	8
Airhorn Leslie M3	9
Airhorn Wabco A2	10
Airhorn Wabco E2	11
Airhorn Holden K5H	12
Hancock Air Whistle	13
Airhorn Fairbanks Morse Trainmaster	14
Airhorn Baldwin switcher 3-chime	15



# Decoder settings - Sound options

## Steam Decoders

Whistle Name	CV 48 value
CB&Q 5-chime short bell	0
D&RG 5 chime step-top cast-iron whistle	1
Great Northern 5 Chime	2
Hancock 3 chime	3
Hancock 3 chime short bell	4
Southern 3 chime cast iron	5
NewYork Central 5 chime	6
New York Central 6 chime	7
Norfolk & Western	8
Northern Pacific	9
Oldtime 3 Chime	10
Reading 6 Chime	11
Shay 4	12
JT&P Southern 610	13
Union Pacific Hancock 3-chime steamboat style	14
Western Locomotive Supply 6-chime	15

Please note the relative value for CV 48 based you your selection.

Some Sound Profiles may include Specific Horns not listed in the following charts. Please go to our website on the Select Download Page. And click on the details tab for further information on each specific Sound Profile.

### 5.2.7.2. Prime mover sound selection

Each LokSound Select decoder contains up to four prime mover sounds. Please refer to the download section of our website to see how many prime mover sounds your Select offers.

Prime mover	CV 48 value
Prime mover sound #1	0
Prime mover sound #2	16
Prime mover sound #3	32
Prime mover sound #4	48

Based upon your selection, the value for CV 48 must be increased by the value you can find in the table above.

### 5.2.7.3. Bell selection

Each LokSound Select Decoder offers two different bells.

Bell type	CV 48 value
Bell slow type	0
Bell fast type	64

Based upon your selection, the Value for CV 48 must be altered according to the setting found in the table above.

### 5.2.7.4. Brake squeal selection

Each LokSound Select Decoder offers two different brake squeal sounds.

Brake squeal selection	CV 48 value
Brake squeal #1	0
Brake squeal #2	128

Based upon your selection, the Value for CV 48 must be altered according to the setting found in the figure above.

Please have a look on the example on the next page to understand how to compute the complete value of CV 48.

## Decoder settings - Sound options

In order to compute the complete value you need to store in CV 48, please follow this procedure:

1. From the figure in section 5.2.7.1., note the value shown for your desired air horn.
2. From the figure in section 5.2.7.2., note the value shown for your desired prime mover sound.
3. From the figure in section 5.2.7.3., note the value shown for your desired bell selection.
4. From the figure in section 5.2.7.4., note the value shown for your desired brake squeal selection.
5. Add all 4 values and write the sum into CV 48.
6. Allow a power cycle of your LokSound Select decoder. After the new startup, the values will be enabled.

### Example:

You would like to have the Leslie S5 air horn, the prime mover sound #2, the slow bell and the brake squeal number 2. So you need to write  $8+16+64+128=216$  into CV 48.

### **5.2.7.5. Bell rate**

Although you can already select between two different bells, you can even adjust the bell rate in 255 steps to adjust the bell sound to your ear by changing the value of CV 285. If you want to have a slower bell, you should change the default value (128) to a smaller value, if you prefer a faster bell, you should put any value greater than 128 in CV 285.

Make sure that the index register CV 32 is set to 1, before you do any changes to CV 285.

### **5.2.7.6. Adjust the sound volume**

The LokSound Select allows the individual volume control of each sound. Please refer to the following table to see which CV you need to change:

**LokSound Select Steam sound volume control table**

Function (Steam)	CV	Default
Master volume control	63	180
Steam Chuff Sound Right side	259	99
Steam Chuff Sound Left side	267	99
Whistle Volume Control	275	128
Bell Volume Control	283	99
Coupler Sound Volume Control	291	128
Dynamo	299	128
Air pump	307	128
Blower	315	128
Injector	323	128
Crossing Comm Sound Volume Control	331	128
Railclank Volume Control	339	60
Brake Set / Brake Release	347	128
Sanding valve Volume Control	355	128
Oil burner (oil fired engines)	363	128
Coal shoveling	371	128
Short whistle	379	128
Johnson bar	387	80
Open cylinder cocks	395	128
Steam hissing (steam boiler)	443	99

**LokSound Select Diesel sound volume control table**

Function (Diesel)	CV	Default
Master volume control	63	180
Diesel Volume Control	259	99

## Decoder settings - Sound options

Horn Volume Control	275	128
Bell Volume Control	283	128
Coupler Sound Volume Control	291	128
Dynamic brake Volume Control	299	128
Air Compressor Volume Control	307	128
Radiator Fan Volume Control	315	128
Detector Sound Volume Control	323	128
Crossing Comm Sound Volume Control	331	128
Railclank Volume Control	339	64
Brake Set / Brake Release	347	128
Sanding valve Volume Control	355	128
Short Air Let Off Volume Control	363	128
Short Airhorn Volume Control	371	128

### Random sound volume control table

Function	Sound slot	CV	Range	Default
Random sounds	-	451	0 – 128	128
Brake sound	-	459	0 – 128	128



Before you change any of the volume control CVs, please make sure that the **CV 32 is set to 1!** As explained earlier, CV 32 is used as an index selection register to distinguish between the real function of CV 257–511.



The master volume control CV 63 controls all sound effects. The resulting sound volume for each individual sound effect therefore is a mixture of the master volume control settings and the individual volume control sliders.

When you adjust the volume levels, please keep in mind that you should not exceed the maximum mixer levels to avoid a condition called “clipping” which occurs when the sum of two or more signals exceeds the capacity of the output channel.

Clipping can be identified by clicking or popping sounds. To avoid this situation, consider which sounds are likely to be played at the

same time and take care that their corresponding volume levels are not set too high.

### 5.2.7.7. Prime mover startup delay

Usually, when the LokSound Select sound is idling and you turn up the throttle, the locomotives begin to move only after the diesel engine has reached notch 1. Although this behavior is very prototypically, one might not like it because it causes some delay.

You can disable this startup delay by simply deleting bit 3 of CV 124. This will cause the LokSound Select decoder to immediately start moving when the throttle is turned up.

### 5.2.7.8. Manual notching (Diesel only)

Most Diesel / Electric locomotives in the world use notched fuel controls to determine how much power the engine is supplying to the generator, which in turn supplies electrical power to the traction motors at the driving wheels.

In general the number of notches is 8, with the driver selecting notches 1 through 8 as required in driving the locomotive. Since there is no direct connection between the locomotive engine, and the driving wheels, engine RPM is fully decoupled from the speed of the locomotive over the rails. Therefore a locomotive may be moving 15 mph going up a grade with a heavy train pulling hard in notch 8 at full RPM, or coasting down a hill at 60 mph with the locomotive idling at notch 1. LokSound (V4.0) (Select) now allows this driving characteristic to be fully modeled on your layout.

LokSound (V4.0) (Select) decoders support full manual notching capability for Diesel / Electric sound projects beginning at Lok-Programmer Software version 4.3.0 and beyond. Sound projects created with previous versions of the software are updated to manual notching capability when opened and a firmware update is performed on the decoder. You may find that you need to map the “Manual Notch up” and “Manual Notch down” keys to your preferred Function (F) buttons.

In order to establish manual notching on your sound project and decoder, you should first open the sound project you wish to enable using version 4.3.x programming software. Assuming it was

## Decoder settings - Brake sectors

created prior to V4.3.0 software you will need to do an “Update Decoder Firmware” from the “Tools” menu. Then open the “Function mapping” section of the software, select 2 function keys you wish to devote to MN, open the dropdown menu in the column labeled “Logical functions”, and select the option for either “Diesel notch up” or “Diesel notch down”, put one selection on each of the 2 keys. These keys are now designated for notch control. (Manual Notching is not required to be in place, if you wish not to use it, simply do not set up the function keys for MN, you can come back at anytime to enable the capability, or remove it.)



Then write the updated sound project to the decoder, and you are ready to run with manual notching.

Once you set up your sound project for manual notching (MN) and write the sound project to the decoder, manual notching is easy to use. 2 function keys are required for MN to operate, one key for notch up, and the other key for notch down. MN can be engaged when the model is standing with engine running, or engaged on the fly after moving off in the normal manner.

When standing, press notch up, engine will notch up the drive RPM sound as determined by each drive step in the project. The number of notches increased depends on how long the key is engaged, and when the key is disengaged it will hold the notch it settles at. (With a little practice you will be able to “time” your desired notch.) You can then use the down notch key and reduce notch, or engage until RPM settles at idle.

While running, operation is the same; engine sound is fully decoupled from locomotive speed, so you can now simulate the full spectrum of locomotive operation just as you can observe by watching operating prototype locomotives in action on the rails. Once you have engaged MN it stays in effect until the locomotive is brought to a stop, AND the sound is brought down to idle. Then the operation reverts to normal pre-manual notching behavior, and can be engaged again when you wish. You do not need to change a CV to go between Manual Notching and Normal Notching. This can be done “on the fly” as you feel it is desired.

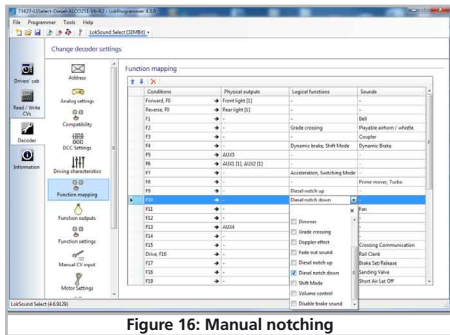

Figure 16: Manual notching

### 5.2.7.9. Synchronizing the steam chuff (Steam decoder only)

To synchronize the steam chuff with the wheel revolutions, you may use an external cam as described in chapter 4.2.5. However, most users prefer not do such massive changes on their valuable locomotives and prefer to use the automatic exhaust mode of the LokSound Select decoder. Because of the excellent Back-EMF function, the synchronization will be satisfying most users.

To enable this function (and disable any external cam at the same time), CV 57 and CV 58 are used. All you need is a stop-watch and a little time. It pays to spend some time in order to achieve an optimal result. This feature works best with Back-EMF control.

In CV 57, the distance between two steam chuffs at the lowest possible speed (at speed step 1) is defined. The unit of CV 57 is a multiple of 32 ms (Milliseconds).

In CV 58, you need to give the LokSound Select some information about the gearing of your engine.

## Decoder settings - Brake sectors

You should proceed as follows:

1. Put the engine onto the track and drive it with speed step 1, while the sound is on.
2. Using the stop-watch, measure the time in seconds it takes the driver to complete one turn at this speed.
3. Divide the time by 0.128 (assuming you are using a 2 cylinder or 4-cylinder locomotive)
4. Enter a rounded value without decimal point in CV 57.
5. Observe the locomotive and check if now 4 steam chuffs will be reproduced per revolution. If needed, adjust the value of CV 57 gradually by increasing or decreasing the value one by one.
6. If you are satisfied, increase the speed of your locomotive to speed step 4 (of 28).
7. Try to observe, if still four steam chuffs per revolution can be heard. If you find that there are too many steam chuffs, increase the value of CV 58 (defaults to 43). If they are too slow, decrease the value of CV 58.

### 5.2.7.10. Random sounds

The LokSound Select offers some random sounds, such as air compressor. This sound will be played-back in random intervals. You can adjust the "rate" for these sounds.

In CV 61, you need to set the minimum delay between two random sounds. The unit is 0.25 seconds. The default value of 75 results in 18.75 seconds.

In CV 62, you can set the maximum delay between two random sounds. The unit is 0.25 seconds. The default value of 200 results in 50 seconds.

If you don't like random sounds, simply set CV 61=0 and CV 62=0 to disable this feature.

### 5.2.7.11. Pop valve sound (Diesel only)

On many locomotives, a pop valve releases air automatically at random intervals. A high frequency, hissing noise can be heard. ON the LokSound Select, if you press F21 you can hear this sounds. However, some throttles do not offer this function key. You may therefore decide to enable the pop valve sound together with the prime mover sound (F8).



If you want to do so, simply set CV 415 to 64 ( and make sure that CV 32=2 before you do that).

## 5.2.8. Step 8: Additional Functions of the LokSound Select

### 5.2.8.1. Brake sectors

Brake sectors have the purpose to slow down the locomotive independently from the commands issued by the command station. Frequently, this function serves for stopping a train in front of a red signal. If a LokSound Select detects a brake command, it will slow down with the programmed deceleration and then stop. After this enforced stop, the locomotive will accelerate again as per the programmed values in CV 3.

Depending on the type of digital system, there are several options on how to influence the decoder so that it stops the train. You need to tell the LokSound Select, which braking system you use.

Your choice will have to be stored in CV 27.

#### 5.2.8.1.1. Brake on DC

Brake on DC means that the LokSound Select will brake if DC power is present on the track. The decoder will start braking once it moves from a digital sector into a DC sector provided the brake mode is active and the polarity of the track voltage does NOT match the current direction of travel. The locomotive will stop taking into account the programmed deceleration time (CV 4).

In order to activate the DC brake mode you must set CV 27 to 16.

#### 5.2.8.1.2. Brake on Asymmetrical DCC signal (ABC braking)

German company Lenz® invented this system. In order to brake the train, a section of the train must be isolated and using some anti-parallel diodes, the voltage of one half of the DCC signals will be reduced by around 1V. If the decoder detects this asymmetrical DCC signal, it will bring the train to a stop.

To enable the asymmetrical DCC braking, you should set CV 27 to 3.

## Decoder settings - Brake sectors

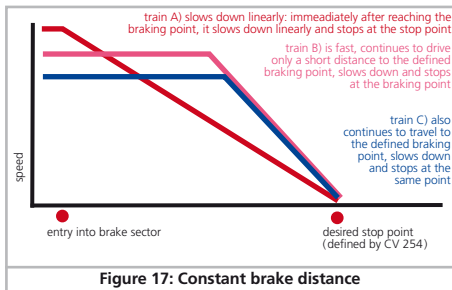

Figure 17: Constant brake distance

### 5.2.8.2. Constant brake distance

An attractive function hides behind CV 254 (Constant brake mode): Here you can set a constant distance for braking the train, from the beginning of the brake sector to the stopping point. Thus, it is possible to stop the train right in front of a red signal regardless of the speed. The LokSound Select simply calculates the required brake effect.

The higher the value in CV 254, the longer the braking distance. Simply make some trials on a test track in order to find the values best suited to your locomotive.

If CV 254 is set to 0, then the normal time mode will automatically turn on.



The constant brake distance is only active in brake sectors. When you turn the throttle back to 0, the locomotive will slow down as per the value in CV 4.

Via CV253 you can choose how the LokSound Select should decelerate.

CV253=0:

The loco starts immediately to stop linearly after receiving the braking command. The dashed line in Figure 17 shows the linear braking distance.

CV253>0:

If the locomotive is relatively slow at the time of the braking command, it continues to drive slowly ahead for some time until it stops. If the locomotive drives very quickly when entering the braking command, it will be stopped earlier, but with the same delay. Figure 17 shows this quite clearly. The higher the value of CV 253, the stronger the braking influence. You need to do some testing to find suitable values for your locomotive.

### 5.2.8.3. Analog DC settings

You can adjust the acceleration and maximum speed of the LokSound Select separately for analog DC and AC mode. Thus, you can also adapt the speed of your locomotive to analog operations.

You will have to determine suitable values by trial and error since they depend on the type of transformer (throttle) and the drive system of your locomotive.

Please note that Back-EMF is always active ex works, even in analogue mode. This gives you smooth control even at very low speeds.

#### 5.2.8.3.1. Analog DC startup and max voltage

You can adjust the starting and maximum speed in DC analog mode using CVs 125 and 126.

#### 5.2.8.3.2. Analog function Enable

LokSound Select allows you to force a function to be ON whenever the decoder switches to analog mode. This is very useful for turning on lighting effects when running on a DC powered layout. You may also enable sound functions, but this may not be very useful as they would be turned on all the time while the decoder

# Firmware Update

stays in analog mode. There are two CVs defining, which function key is in on state: CV 13 and CV 14. Have a look on the two tables below. Note the numbers of the functions you want to enable, sum the values found and write this into either CV 13 or 14.

## Analog Function Control 1

CV #	F1	F2	F3	F4	F5	F6	F7	F8
13	1	2	4	8	16	32	64	128

## Analog Function Control 2

CV #	F0(f)	F0(r)	F9	F10	F11	F12		
22	1	2	4	8	16	32		

### 5.2.9. Prime mover Sound On / Off behavior

The LokSound Select is slightly different from other North American sound decoders in that the Sound is OFF as default and can be turned on use F8. This is done for a number of reasons. First, this gives you the opportunity to hear and appreciate the start up sounds. Second, with the advent of sound in DCC many people have a vast collection of sound equipped locomotives on their layout. When the power is first turned on from the command station all these sound equipped locomotives will start up at the same time. This results in a very unrealistic start up of everything coming on at once. Further, there is huge drain on your command station that can cause internal breakers to trip. We have decided to have our decoder be silent until you call upon them. This is an option though and can be changed with CV's.

First you will need to set the Index CV 32 to 2. Then you will need to set CV 403 to a Value of 32.

You will then need to change CV 13 to a value of 0 so that the sound will be on in DC mode.

These settings can also be easily changed with our Programmer Software by changing the function mapping for F8 to be (not F8) in the conditions drop down menu.

## 6. Firmware Update

You can update LokSound Select decoders with new operating software (so-called firmware) at any time. This is useful for fixing bugs and implementing new functions.

You can carry out the update yourself without having to remove the decoder from the locomotive. All you need is the ESU LokProgrammer. The most recent version of the firmware can be downloaded free of charge from our website.



Updates which are carried out by our service department will not be treated as a case of warranty. Therefore we will charge you for this service. Please inquire about the cost on our website before you send in a decoder.

Only change the firmware if you want to fix bugs that are relevant to you or if you want to introduce new essential functions. Otherwise, never change the configuration of a system that works reliably.

## 7. List of CVs

CV	Name	Description	Range	Default																		
1	Primary address	Primary address of engine. See chapter 5.2.1. for details	1-127	3																		
2	Start voltage	Sets the minimum speed of the engine in DCC operation	1-255	3																		
3	Acceleration Rate	This value multiplied by 0.25 is the time from stop to maximum speed	0-255	16																		
4	Braking rate	This value multiplied by 0.25 is the time in seconds from maximum speed to stop	0-255	32																		
5	Maximum speed	Maximum speed of the engine	0-64	64																		
6	Medium speed	Medium speed of the engine	0-64	64																		
8	Manufacturer ID	Manufacturer's ID - ESU -	151	151																		
13	Analog mode function status #1	Functions F1 to F8 in analog mode. See chapter 5.2.8.3.2. for details	0-255	128																		
14	Analog mode function status #2	Functions FL, F9 to F12 in analog mode. See 5.2.8.3.2. for details	0-255	3																		
17 18	Extended address	Extended address (long address). See chapter 5.2.1. for details																				
19	Consist address	Additional address for consist operation. See chapter 5.2.3. for details	1-127	0																		
21	Consist mode function status #1	Functions F1 to F8 in consist mode. See chapter 5.2.3.1. for details	0-255	0																		
22	Consist mode function status #2	Functions FF, F9 to F8 in consist mode. See chapter 5.2.3.1. for details	0-255	0																		
27	Brake mode configuration	Defines which brake modes are active. See chapter 5.2.8.1. for details	0-255	24																		
		<table border="1"> <thead> <tr> <th>Function</th> <th>Bit</th> <th>Value</th> </tr> </thead> <tbody> <tr> <td>Brake on asymmetrical DC - higher voltage on right track</td> <td>0</td> <td>1</td> </tr> <tr> <td>Brake on asymmetrical DC - higher voltage on left track</td> <td>1</td> <td>2</td> </tr> <tr> <td>Brake on Zimo® HLU commands</td> <td>2</td> <td>4</td> </tr> <tr> <td>Brake on DC</td> <td>4</td> <td>16</td> </tr> </tbody> </table>	Function	Bit	Value	Brake on asymmetrical DC - higher voltage on right track	0	1	Brake on asymmetrical DC - higher voltage on left track	1	2	Brake on Zimo® HLU commands	2	4	Brake on DC	4	16					
Function	Bit	Value																				
Brake on asymmetrical DC - higher voltage on right track	0	1																				
Brake on asymmetrical DC - higher voltage on left track	1	2																				
Brake on Zimo® HLU commands	2	4																				
Brake on DC	4	16																				
29	Configuration register	The most complex CV within the DCC standards. This register contains important information for setting up your decoder	0-255	6																		
		<table border="1"> <thead> <tr> <th>Function</th> <th>Bit</th> <th>Value</th> </tr> </thead> <tbody> <tr> <td>Reverse direction of travel (forward becomes reverse)</td> <td>0</td> <td>1</td> </tr> <tr> <td>Speed steps: 0=14 speed steps, 2=28/128 speed steps</td> <td>1</td> <td>2</td> </tr> <tr> <td>Analog mode enable, 4=Analog mode enabled</td> <td>2</td> <td>4</td> </tr> <tr> <td>Speed curve selection. 0=CV2,5,6 ; 16= CV 67-94</td> <td>4</td> <td>16</td> </tr> <tr> <td>Address select. 0=Primary address, 32=Extended address</td> <td>5</td> <td>32</td> </tr> </tbody> </table>	Function	Bit	Value	Reverse direction of travel (forward becomes reverse)	0	1	Speed steps: 0=14 speed steps, 2=28/128 speed steps	1	2	Analog mode enable, 4=Analog mode enabled	2	4	Speed curve selection. 0=CV2,5,6 ; 16= CV 67-94	4	16	Address select. 0=Primary address, 32=Extended address	5	32		
Function	Bit	Value																				
Reverse direction of travel (forward becomes reverse)	0	1																				
Speed steps: 0=14 speed steps, 2=28/128 speed steps	1	2																				
Analog mode enable, 4=Analog mode enabled	2	4																				
Speed curve selection. 0=CV2,5,6 ; 16= CV 67-94	4	16																				
Address select. 0=Primary address, 32=Extended address	5	32																				



# List of CVs

CV	Name	Description	Range	Default	
32	Index register	Index register for access of CVs 257–511	0, 1, 2, 3	0	
48	Master Sound select	Selects the Prime mover sound, Horn sound, Bell sound, brake squeal sound. See chapter 5.2.7. for details	0–255	3	
49	Extended configuration	Additional settings for LokSound Select Decoder		19	
		Function	Bit		Value
		Enable Back EMF–Contro. 0=Disable, 1 = Enable	0		1
		Motor PWM frequency. 0=20 kHz, 1 =40 kHz	1		2
		Automatic DCC speed step detection. 16=Enable automatic speed step detecion	4		16
	LGB® function button mode (sequential LGB functions) 32=Enable LGB® function button mode	5	32		
50	Analog mode	Selection of allowed analog modes	0, 2	2	
		Function	Bit		Value
		2=Enable DC analog mode	1		2
52	Back–EMF Slow speed amplifier	Increases the power of the Back–EMF function at low speed operation. Increase this value if the locomotive jerks at low speeds.	0–255	32	
53	Back–EMF Reference voltage	Defines the Back–EMF voltage which the motor should generate at maximum speed. Unit: 0.1 Volts	0–255	140	
54	Back–EMF Parameter «K»	«K» component of the internal PI–controller. See chapter 5.2.4. for details	0–255	48	
55	Back–EMF Parameter «I»	«I» component of the internal PI–controller. See chapter 5.2.4. for details	0–255	32	
56	Back–EMF Dynamic Drive Control	Defines the influence of the Back–EMF control. See chapter 5.2.4.5. for details	0–255	255	
57	Sound trigger #1	Defines if an external CAM is used for sound chuff synchronization or automatic exhaust is desired. See chapter 4.2.5.1. & 5.2.7.9.	0–255	143	
58	Sound trigger #2	Defines if an external CAM is used for sound chuff synchronization or automatic exhaust is desired. See chapter 4.2.5.1. & 5.2.7.9.	0–255	43	
59	Sound speed minimum	Defines the playback–speed of the motor sound at idle speed. A value higher than 128 means faster than factor 1.0, a value lower than 128 means a factor lower than 1.0	0–255	128	

# List of CVs

CV	Name	Description	Range	Default
60	Sound speed Maximum	Defines the playback-speed of the motor sound at maximum speed. A value higher than 128 means faster than factor 1.0, a value lower than 128 means a factor lower than 1.0	0-255	160
61	Random sound minimum range	Defines the minimum range between two random sounds. Unit is 0.25 seconds. See chapter 5.2.7.9. for details	0-255	75
62	Random sound maximum range	Defines the maximum range between two random sounds. Unit is 0.25 seconds. See chapter 5.2.7.9. for details	0-255	200
63	Master volume control	Master volume control. See chapter 5.2.7.6. for details	0-192	180
66	Forward Trim	See chapter 5.2.2.4. for details	0-255	128
67-94	Speed table	Defines motor voltage for speed steps. The values «between» will be interpolated. See chapter 5.2.2.3. for details	0-255	
95	Reverse Trim	See chapter 5.2.2.4. for details	0-255	128
105	User CV#1	In this CV the user can store any value he wants to	0-255	0
106	User CV#1	In this CV the user can store any value he wants to	0-255	0
112	Flash rate	Defines the flash rate for all physical outputs. The unit is 0.0625 seconds. See chapter 5.2.6.4. for details	0-255	30
124	Extended Configuration #2	Additional important settings for decoders	-	24
		Function	Bit	Value
		Bi-directional bit: Enable driving direction when shifting direction	1	1
		Disable driving direction		0
		Disable decoder lock with CV 15 / 16	2	0
		Enable decoder lock with CV 15 / 16		2
		Disable prime mover startup delay	3	0
		Enable prime mover startup delay		4
		Disable serial protocol for C-Sinus	4	0
		Enable serial protocol for C-Sinus		8
		Adaptive regulation frequency	5	0
		Constant regulation frequency		16
125	Analog DC Starting voltage	Defines the starting voltage of the motor in DC operation.	0-255	70
125	Analog DC Vmax voltage	Defines the voltage of the motor when running VMax in DC operation	0-255	120

## List of CVs

CV	Name	Description	Range	Default
131	Diesel manual notching offset	Defines the value added to the internal diesel speed when manual notching is active. See chapter 5.2.7.8. for details	0–255	50
132	Grade crossing holding time	Defines the time the grade crossing effects are active after the horn is turned off. Unit is 0.0625 seconds. See chapter 5.2.6.3. for details	0–255	80
253	Constant brake mode – brake rate	Defines the rate at which the locomotives brakes if the constant brake mode is enabled. This value depends on CV 254 > 0.	0–255	0
254	Constant brake mode – brake distance	Defines the distance for the constant brake mode. If CV 254 equals 0, the constant brake mode is disabled. See chapter 5.2.8.2. for details	0–255	0
257– 255	Indexed CVs	The values of these CVs depend on the content of the Index register CV 32. These CVs are used for physical output settings, volume control and function mapping. The detailed description of these CVs can be found anywhere in the manual.		

## 8. Support

Your model train dealer or hobby shop is your competent partner for all questions regarding your LokSound Select decoder. In fact he/she is your competent partner concerning all questions around model trains.

Of course, you may also contact us directly. The best way is to register for our support forum and ask your questions there. Either an ESU staff or other members of the forum will be glad to help you.

You can register here:

<http://www.esu.eu/nc/en/register/>

Please call our hotline only in case of complex enquiries that can't be dealt with by email or fax. The hotline is often very busy and you may encounter delays. Rather check our website for more information. You will find many hints under "Support / FAQ" and even feedback from other users that may help you with your particular question.

Of course we will always assist you; please contact us at:

Phone: + 1 570-854-5046  
Monday, Wednesday & Friday 9:00am - 5:00pm (EST)  
Fax: +1-866-591-6440  
Mail: ESU LLC  
477 Knopp Drive  
Muncy PA 17756

[www.loksound.com](http://www.loksound.com)

## 9. Appendix

### 9.1. How to program long addresses

As described in chapter 5.2.1.2, the long address is separated into two CVs. In CV 17 you will find the higher-valued byte of the address. This byte determines the section, in which the address will lie. Is there, e.g., a value of 192 in CV 17, the extended address can accept values between 0 and 255. Is there a value of 193 in CV 17, the extended address can accept values between 256 and 511. This can be continued up to a value of 231 in CV17, then the extended address can take a value of 9984 and 10239. In the table on the right, all possible sections are listed. To calculate the values refer to the following:

- First determine the address desired, e.g. 4007.
- Refer to the values shown the figure on the right hand side, and choose the address section concerned. In the right column next to the address section chosen you will find the numerical value you have to write in C17, here our example for 207:

CV 18 is appraised as follows:

	address desired	4007
minus	first address found in address section -	3840
	=====	=====
equals	value of CV 18	167

- Figure 167 is now the value you have to write in CV 18, thus your decoder is responsive to address 4007.

# Appendix

If you wish to read out your addresses, please read out CV 17 and CV 18 one after another and flip the process:

Let's say you read out the following:

CV 17= 196; CV 18= 147. For the corresponding address section look on fig. 19. The first possible address of this section is 1024. Now you have to add it to the value of CV18, and you will just know the address of the loco:

$$\begin{array}{r} 1024 \\ + \quad 147 \\ \hline = \quad 1171 \end{array}$$

Address sections			Address sections			Address sections		
from	to	CV 17	from	to	CV 17	From	to	CV 17
0	255	192	3584	3839	206	7168	7423	220
256	511	193	3840	4095	207	7424	7679	221
512	767	194	4096	4351	208	7680	7935	222
768	1023	195	4352	4607	209	7936	8191	223
1024	1279	196	4608	4863	210	8192	8447	224
1280	1535	197	4864	5119	211	8448	8703	225
1536	1791	198	5120	5375	212	8704	8959	226
1792	2047	199	5376	5631	213	8960	9215	227
2048	2303	200	5632	5887	214	9216	9471	228
2304	2559	201	5888	6143	215	9472	9727	229
2560	2815	202	6144	6399	216	9728	9983	230
2816	3071	203	6400	6655	217	9984	10239	231
3072	3327	204	6656	6911	218			
3328	3583	205	6912	7167	219			

# 10. Warranty

## 24 MONTHS WARRANTY FROM DATE OF PURCHASE

Dear customer,

Congratulations on purchasing this ESU product. This quality product was manufactured applying the most advanced production methods and processes and was subjected to stringent quality checks and tests.

There is a statutory two-year period of warranty for all ESU products. This period is valid from the moment you buy the LokSound Select decoder at your retailer's shop. If the product fails to work properly within this two-year period, warranty claims come into effect. You have the possibility to return the decoder to your retailer's shop where it was purchased and arrange any further action with him/her.

ESU offers the possibility to return the decoder directly to the company's service dept.

ESU LLC  
477 Knopp Drive  
Muncy PA 17756  
USA

We recommend that you use this option when your retailer no longer exists or when you have to drive a long distance to get to another retailer. Due to liability reasons any inspections or repairs can only be carried out on products that are not installed in a locomotive or carriage. Any locomotive sent to ESU for inspection will be returned without even touching it. There is no extension of the warranty period due to any repairs or replacements carried out by ESU.

Should you assert your guarantee claims directly against ESU, please note the following:

- This warranty is valid for all ESU products that have been purchased from an authorized dealer.
- No claims will be accepted without proof of purchase. The filled in warranty certificate together with your ESU dealer's receipt serves as proof of purchase. We recommend keeping the warranty certificate together with the receipt.
- In case of claim please fill in the enclosed fault description as detailed and precisely as possible and return it with your faulty product.

This warranty covers free of charge repair or replacement of the faulty part, provided the failure is demonstrably due to faulty design, manufacturing, material or transport. Any further claims are excluded.

The warranty expires:

1. In case of wear and tear due to normal use
2. In case of conversions of ESU - products with parts not approved by the manufacturer.
3. In case of modifications of parts, particularly missing shrink sleeves, or wires directly extended on the decoder.
4. In case of inappropriate use (different to the intended use as specified by the manufacturer).
5. If the instructions as laid down in the user manual were not adhere to.

### SERVICE REPAIRS

Naturally it is also possible to repair a LokSound Select decoder, which is out of the warranty. In this case please send the decoder to our service department. Our technicians will check the item and decide if it can be repaired. Please check our website [www.loksound.com](http://www.loksound.com) for the repair cost and procedure. If any doubt, contact with us prior to sending any decoders to us.



# Trouble Shooting Sheet

## 1. Personal information

(Please use block letters)

Name: .....

Street: .....

ZIP code/ city: ..... | | | | |

Country: .....

Email: .....

Telephone: .....

Date: .....

Signature: .....

## 2. Product details and system environment











Art.No.: \_\_\_\_\_ Date of purchase: \_\_\_\_\_ Address : \_\_\_\_\_

Operation mode:  DC Analog  DCC

Command station:  ESU ECoS  Digitrax®  MRC®  NCE®  Bachmann®

Lenz® Digital  Others:

## 3. Error description

<input type="checkbox"/> headlight output front 	<input type="checkbox"/> no sound 	<input type="checkbox"/> wire harness 
<input type="checkbox"/> headlight output rear 	<input type="checkbox"/> wrong sound 	<input type="checkbox"/> change direction problems 
<input type="checkbox"/> motor output 	<input type="checkbox"/> short circuit 	<input type="checkbox"/> without any function (DOA)
<input type="checkbox"/> programming 	<input type="checkbox"/> AUX outputs fail 	<input type="checkbox"/> Other problems: _____

## 4. Proof of purchase (please enclose this document!)

Please enclose your receipt / invoice. Otherwise no warranty possible!

## 5. Additional information:

## 6. Your retailer:

\_\_\_\_\_

\_\_\_\_\_

\_\_\_\_\_

\_\_\_\_\_

\_\_\_\_\_

\_\_\_\_\_

\_\_\_\_\_

\_\_\_\_\_

\_\_\_\_\_

\_\_\_\_\_

\_\_\_\_\_

\_\_\_\_\_

Retailer's stamp or address

